

GLOVES, PERSONAL  
PROTECTION & SAFETY  
PRODUCTS



## THE SAFETY ZONE

---

For over 40 years, The Safety Zone has been partnering with our clients to ensure their successes. Our experience supplying the industrial safety, janitorial, food service, food processing and medical markets extends worldwide. We'll customize our services to fit your objectives, adding valued insight that, in combination with our comprehensive selection of superior PPE products, will enhance your sales. From a small order to a full container or truckload, we have the ability to meet and exceed all of your PPE needs.



# TABLE OF CONTENTS



Disposable Glove Development.....	4	Isolation Gowns.....	63
World Pandemic Timeline .....	5	Aprons.....	65
History of Safety Zone, Impact Products & Supply Source .....	5	Eye Protection & Accessories.....	69
Disposable Nitrile Gloves .....	6	Hearing Protection .....	71
Disposable Vinyl Gloves .....	14	Respirators & Masks .....	72
Disposable Latex Gloves .....	21	Sharps Containers & Eyewash Stations.....	73
Disposable Poly Gloves .....	25	First Aid Kits.....	74
Chemical & Flock Lined Gloves .....	30	Bloodborne Pathogen Kits .....	75
Coated Knit Gloves .....	37	Back Supports, Knee Pads & Dispenser Racks .....	76
Dotted Gloves .....	41	Wet Floor Signs .....	77
Inspector Gloves .....	42	Safety Signs & Accessories .....	78
String Knit Gloves .....	43	Four-Sided Floor Signs & Wet Floor Cones.....	79
Shoe & Boot Covers.....	47	Barrier Tape, Lock-In Sign, Safety Cones & Floor Dams .....	80
Sleeves .....	51	SDS Information Center, Hand Sanitizer & PPE Station.....	81
Hoods, Beard Covers & Hairnets .....	53	Glove Chemical Resistant Chart.....	82
Bouffants .....	55	Glove Sizing Chart.....	83
Beard Covers & Beard Nets.....	57		
Lab Coats .....	59		
Coveralls .....	61		

## A Guide to the Glove Icons Used in This Catalog



Laboratory



Food  
Service



Veterinary  
Services



JanSan



Medical



Dental



### Proposition 65

Our gloves are compliant with Proposition 65 requirements in the State of California.

## 130+ YEARS AGO

Single use gloves were first introduced by Stewart Halsted in 1894, when he worked at Johns Hopkins as Chief Surgeon. The innovation of dipping hand formers in liquid latex to create surgical gloves was documented to reducing post operative infections. Latex gloves were slowly integrated into operating rooms and laboratories for patient, Dr and RN protection.

## 90+ YEARS AGO

Tillotson Rubber was founded by Neil Tillotson in 1931, manufacturing latex party balloons and gloves. Nitrile and Vinyl “Synthetic” gloves were developed in the early 1980’s and then patented in the early 1990’s

## 40+ YEARS AGO

The AIDs Pandemic put fear and uncertainty into all facets of health care workers as it was not known how the HIV virus was spread. New protocols were developed that recommended single use gloves be used for bloodborne protection.

## ECOLI, ANTHRAX, SARS, HIN1, EBOLA, ZIKA, EVALI. COVID 19

We began living with Covid 19 and similarly to the AIDs pandemic, nobody was sure how it was transmitted

# WORLD TIMELINE OF PANDEMICS & SUPPLY SOURCE GLOBAL TIMELINE

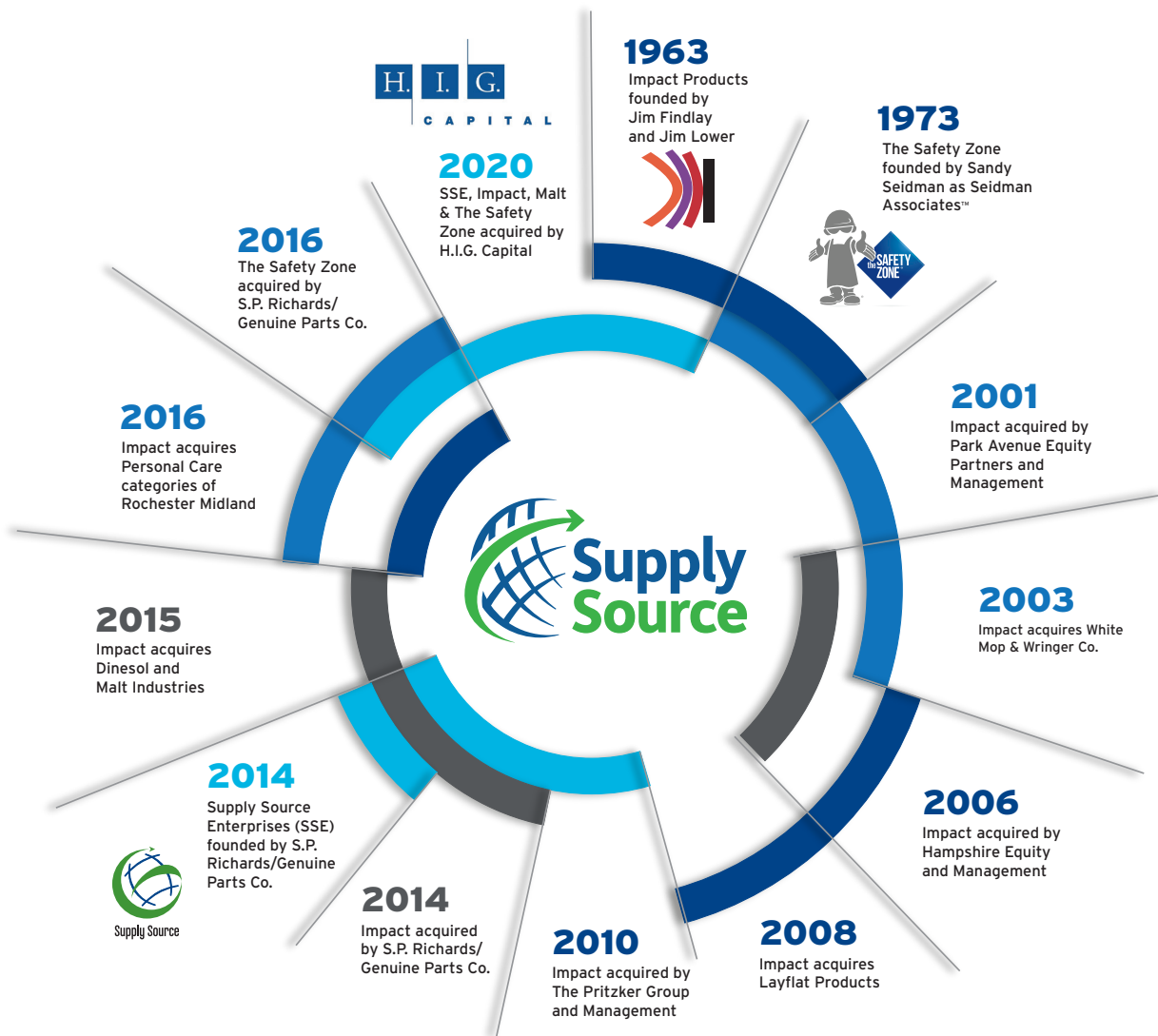
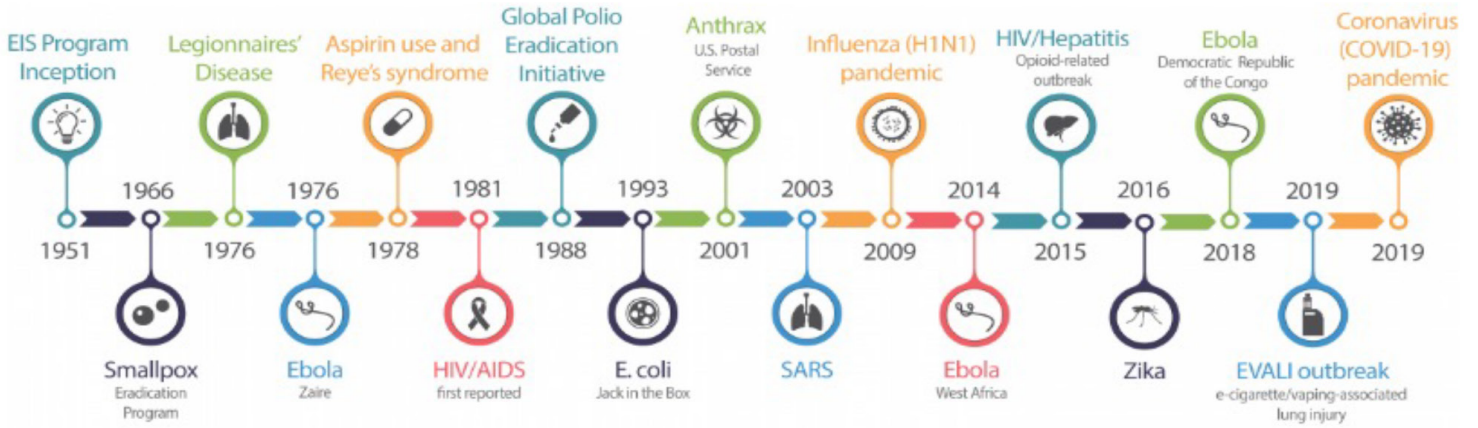

# DISPOSABLE GLOVES - NITRILE

## What are the Pros and Cons of Nitrile Single Use Gloves?

### Pros:

- 100% Synthetic / 100% Latex Free / Zero natural proteins
- Very strong with high tensile strength and elongation
- Holds up very well to Petroleum products like oil and gasoline and has the broadest spectrum of chemical protection
- Has great shelf life and if stored properly are good for over 10 years

### Cons:

- Solvents like acetone have a fast permeation time

## Nitrile Gloves are 100 % Allergen Free



**100 % Latex Free**



### 100% PFAS Free

PFAS also known as Per- and polyfluoroalkyl substances are human-made chemicals used in both consumer and industrial products. PFAS chemicals do not easily breakdown in the environment. Exposure to some types of PFAS have been linked to serious health effects. All PPE products manufactured and distributed by Supply Source are PFAS free.



### 100% Phthalate Free

According to the FDA, Phthalates are a group of chemicals used in hundreds of products, such as toys, vinyl flooring and wall covering, detergents, lubricating oils, food packaging, pharmaceuticals, blood bags and tubing, and personal care products, such as nail polish, hair sprays, aftershave lotions, soaps, shampoos, perfumes and other fragrance preparations.

## Federal Food, Drug, and Cosmetic Act (FD&C Act)

The FD&C Act is a set of laws passed by Congress in 1938 giving authority to the U.S. Food and Drug Administration (FDA) to oversee the safety of food, drugs, and cosmetics. All Safety Zone glove components comply with the provisions of the FD&C Act, which allow repeated use in direct contact with food.

### FDA Rule 110.10 & 177.1950



**Rule 110.10** Nitrile gloves sold by The Safety Zone meet the requirements for handling of human food in both the manufacturing and packaging phases of production.

**Rule 177.1950** Nitrile gloves sold by The Safety Zone contain chloride-ethylene co-polymers, which may be safely used for repeated use when coming into contact with food.

**Disposable nitrile gloves are widely used in various industries and settings for their versatility, durability, and resistance to chemicals. Here are some common uses of disposable nitrile gloves:**

**Medical and Healthcare:** Nitrile gloves are extensively used in healthcare settings, including hospitals, clinics, dental offices, and laboratories. They provide a barrier between healthcare professionals and patients, protecting against cross-contamination and the spread of infections.

**Food Service:** In the food service industry, nitrile gloves are commonly used by kitchen staff, food handlers, and chefs. They help maintain hygiene standards by preventing direct contact between hands and food, reducing the risk of contamination.

**Cleaning and Janitorial Services:** Disposable nitrile gloves are used in cleaning and janitorial services to protect workers' hands from harsh cleaning chemicals, detergents, and other substances.

**Automotive and Mechanics:** Nitrile gloves are favored in the automotive industry because of their resistance to oils, solvents, and chemicals commonly found in automotive fluids.

**Laboratories and Research Facilities:** Nitrile gloves are widely used in laboratory settings, research facilities, and pharmaceutical industries. They offer protection against chemicals, biohazards, and potential contaminants.

**Hair and Beauty Salons:** Disposable nitrile gloves are used by hairstylists, nail technicians, and beauticians to maintain hygiene and prevent the transmission of pathogens. They provide protection when working with chemicals, dyes, and other salon products.

# DISPOSABLE GLOVES - NITRILE

## GNPR-SZ-1A/Nitrile/Powder Free/Blue



Item	Size	Glove Weight* (grams)	Palm Thickness	Finger Thickness	Texture	Quantity	Skid Quantity
GNPR-SM-1A	Small	3.2	3.0 mil +/- 0.5 mil	3.5 mil +/- 0.5 mil	Fingertip	100 bx/ 10 cs	80
GNPR-MD-1A	Medium	3.5					
GNPR-LG-1A	Large	3.8					
GNPR-XL-1A	X-Large	4.1					
GNPR-2X-1A	2X-Large	4.4					

- 100% Latex and PFAS Free
- Textured fingertips for improved grip

\* Glove weights may vary (+/-0.3 grams)



## GNPR-SZ-2/Nitrile/Powder Free/Blue



Item	Size	Glove Weight* (grams)	Palm Thickness	Finger Thickness	Texture	Quantity	Skid Quantity
GNPR-SM-2	Small	3.2	3.0 mil +/- 0.5 mil	3.5 mil +/- 0.5 mil	Fingertip	200 bx/ 10 cs	48
GNPR-MD-2	Medium	3.5					
GNPR-LG-2	Large	3.8					
GNPR-XL-2	X-Large	4.1					
GNPR-2X-2	2X-Large	4.4					

- 100% Latex and PFAS Free
- Textured fingertips for improved grip

\* Glove weights may vary (+/-0.3 grams)



## GNPR-SZ-BK/Nitrile/Powder Free/Black



Item	Size	Glove Weight* (grams)	Palm Thickness	Finger Thickness	Texture	Quantity	Skid Quantity
GNPR-SM-BK	Small	3.7	3.5 mil +/- 0.5 mil	4.0 mil +/- 0.5 mil	Fingertip	100 bx/ 10 cs	65
GNPR-MD-BK	Medium	4.0					
GNPR-LG-BK	Large	4.4					
GNPR-XL-BK	X-Large	4.8					
GNPR-2X-BK	2X-Large	5.0					

- 100% Latex and PFAS Free
- Textured fingertips for improved grip

\* Glove weights may vary (+/-0.3 grams)





### GNPR-SZ-1E/Nitrile/Powder Free/Blue



Item	Size	Glove Weight* (grams)	Palm Thickness	Finger Thickness	Texture	Quantity	Skid Quantity
GNPR-SM-1E	Small	3.7	3.5 mil +/- 0.5 mil	4.0 mil +/- 0.5 mil	Fingertip	100 bx/ 10 cs	64
GNPR-MD-1E	Medium	4.0					
GNPR-LG-1E	Large	4.4					
GNPR-XL-1E	X-Large	4.8					

- 100% Latex and PFAS Free
  - Textured fingertips for improved grip
- \* Glove weights may vary (+/-0.2 grams)



### GNPR-SZ-1M/Nitrile/Powder Free/Blue



Item	Size	Glove Weight* (grams)	Palm Thickness	Finger Thickness	Texture	Quantity	Skid Quantity
GNPR-SM-1M	Small	4.5	4.0 mil +/- 0.5 mil	4.5 mil +/- 0.5 mil	Fingertip	100 bx/ 10 cs	60
GNPR-MD-1M	Medium	4.5					
GNPR-LG-1M	Large	5.1					
GNPR-XL-1M	X-Large	5.4					
GNPR-2X-1M	2X-Large	6.0					48

- 100% Latex and PFAS Free
  - Textured fingertips for improved grip
- \* Glove weights may vary (+/-0.2 grams)



### GNPR-SZ-1M-OR/Nitrile/Powder Free/Orange



Item	Size	Glove Weight* (grams)	Palm Thickness	Finger Thickness	Texture	Quantity	Skid Quantity
GNPR-SM-1M-OR	Small	4.0	4.0 mil +/- 0.5 mil	4.5 mil +/- 0.5 mil	Fingertip	100 bx/ 10 cs	60
GNPR-MD-1M-OR	Medium	4.5					
GNPR-LG-1M-OR	Large	5.0					
GNPR-XL-1M-OR	X-Large	5.5					
GNPR-2X-1M-OR	2X-Large	5.7					

- 100% Latex and PFAS Free
  - Textured fingertips for improved grip
- \* Glove weights may vary (+/-0.3 grams)



ALL SAFETY ZONE GLOVES COMPLY WITH THE FFCA FOR FOOD CONTACT AND ARE PHTHALATE FREE

# DISPOSABLE GLOVES - NITRILE

## GNPR-SZ-1-K/Nitrile/Powder Free/Black



Item	Size	Glove Weight* (grams)	Palm Thickness	Finger Thickness	Texture	Quantity	Skid Quantity
GNPR-SM-1-K	Small	5.3	4.9 mil +/- 0.5 mil	5.2 mil +/- 0.5 mil	Fingertip	100 bx/ 10 cs	48
GNPR-MD-1-K	Medium	5.8					
GNPR-LG-1-K	Large	6.3					
GNPR-XL-1-K	X-Large	6.8					
GNPR-2X-1-K	2X-Large	7.0					

- 100% Latex and PFAS Free
  - Textured fingertips for improved grip
- \* Glove weights may vary (+/-0.3 grams)



## GNPR-SZ-1M-SZR/Nitrile/Powder Free/Indigo



Item	Size	Glove Weight* (grams)	Palm Thickness	Finger Thickness	Texture	Quantity	Skid Quantity
GNPR-SM-1M-SZR	Small	3.2	3.0 mil +/- 0.5 mil	3.5 mil +/- 0.5 mil	Fingertip	100 bx/ 10 cs	80
GNPR-MD-1M-SZR	Medium	3.5					
GNPR-LG-1M-SZR	Large	3.8					
GNPR-XL-1M-SZR	X-Large	4.1					

- 100% Latex and PFAS Free
  - Textured fingertips for improved grip
- \* Glove weights may vary (+/-0.3 grams)



## GNPR-SZ-1/Nitrile/Powder Free/Blue/Heavyweight



Item	Size	Glove Weight* (grams)	Palm Thickness	Finger Thickness	Texture	Quantity	Skid Quantity
GNPR-SM-1	Small	6.3	5.2 mil +/- 0.5 mil	5.7 mil +/- 0.5 mil	Fingertip	100 bx/ 10 cs	48
GNPR-MD-1	Medium	7.1					
GNPR-LG-1	Large	7.8					
GNPR-XL-1	X-Large	8.5					
GNPR-2X-1	2X-Large	9.0					

- 100% Latex and PFAS Free
  - Textured fingertips for improved grip
- \* Glove weights may vary (+/-0.3 grams)





### GNPR-SZ-AZO-D6/Nitrile/Orange Diamond Grip

Item	Size	Gram Weight*	Palm Thickness	Finger Thickness	Texture	Quantity	Skid Quantity
GNPR-MD-AZO-D6	Medium	8.5	7.5 mil +/- 0.5 mil	8.0 mil +/- 0.5 mil	Diamond Grip	100 bx/ 10 cs	48
GNPR-LG-AZO-D6	Large	9.0					
GNPR-XL-AZO-D6	X-Large	9.5					
GNPR-2X-AZO-D6	2X-Large	10.0					

- 100% Latex and PFAS Free
  - Textured fingertips for improved grip
- \* Glove weights may vary (+/-0.5 grams)



### GNDR-SZ-1-MT/Nitrile/Blue/Metal Detectable

Item	Size	Gram Weight*	Palm Thickness	Finger Thickness	Texture	Quantity	Skid Quantity
GNPR-SM-1-MT	Small	5.1	4.7 mil +/- 0.5 mil	5.2 mil +/- 0.5 mil	Fingertip	100 bx/ 10 cs	60
GNPR-MD-1-MT	Medium	5.5					
GNPR-LG-1-MT	Large	6.0					
GNPR-XL-1-MT	X-Large	6.5					
GNPR-2X-1-MT	2X-Large	6.9					

- 100% Latex and PFAS Free
  - Textured fingertips for improved grip
  - Includes Nano Iron Oxide (Fe<sub>3</sub>O<sub>4</sub>) for metal detectability
- \* Glove weights may vary (+/-0.3 grams)



### GNDR-SZ-1M/Nitrile/Powdered/Blue

Item	Size	Gram Weight*	Palm Thickness	Finger Thickness	Texture	Quantity	Skid Quantity
GNPR-SM-1M	Small	4.0	4.0 mil +/- 0.5 mil	4.5 mil +/- 0.5 mil	Fingertip	100 bx/ 10 cs	60
GNPR-MD-1M	Medium	4.5					
GNPR-LG-1M	Large	5.0					
GNPR-XL-1M	X-Large	5.5					
GNPR-2X-1M	2X-Large	5.7					

- 100% Latex and PFAS Free
  - Textured fingertips for improved grip
- \* Glove weights may vary (+/-0.3 grams)



ALL SAFETY ZONE GLOVES COMPLY WITH THE FFDCA FOR FOOD CONTACT AND ARE PHTHALATE FREE

# DISPOSABLE GLOVES - NITRILE - MEDICAL GRADE

## GNEP-SZ-1E/Nitrile/Powder Free/Blue



Item	Size	Gram Weight*	Palm Thickness	Finger Thickness	Texture	Quantity	Skid Quantity
GNEP-SM-1E	Small	3.7	3.5 mil +/- 0.5 mil	4.0 mil +/- 0.5 mil	Fingertip	100 bx/ 10 cs	64
GNEP-MD-1E	Medium	4.0					
GNEP-LG-1E	Large	4.4					
GNEP-XL-1E	X-Large	4.8					

- 100% Latex and PFAS Free
  - Textured fingertips for improved grip
- \* Glove weights may vary (+/-0.3 grams)



## GNEP-SZ-2BL/Nitrile/Powder Free/Blue



Item	Size	Gram Weight*	Palm Thickness	Finger Thickness	Texture	Quantity	Skid Quantity
GNEP-SM-2BL	Small	2.6	2.5 mil +/- 0.5 mil	3.0 mil +/- 0.5 mil	Fingertip	200 bx/ 10 cs	48
GNEP-MD-2BL	Medium	2.8					48
GNEP-LG-2BL	Large	3.3					48
GNEP-XL-2BL	X-Large	3.8					48

- 100% Latex and PFAS Free
  - Textured fingertips for improved grip
  - **While supplies last**
- \* Glove weights may vary (+/-0.3 grams)



## GNEP-SZ-2BK/Nitrile/Powder Free/Black



Item	Size	Gram Weight*	Palm Thickness	Finger Thickness	Texture	Quantity	Skid Quantity
GNEP-SM-2BK	Small	2.6	2.5 mil +/- 0.5 mil	3.0 mil +/- 0.5 mil	Fingertip	200 bx/ 10 cs	48
GNEP-MD-2BK	Medium	2.8					48
GNEP-LG-2BK	Large	3.3					48
GNEP-XL-2BK	X-Large	3.8					56

- 100% Latex and PFAS Free
  - Textured fingertips for improved grip
  - **While supplies last**
- \* Glove weights may vary (+/-0.2 grams)



**GNEP-SZ-1/Nitrile/Powder Free/Blue**

Item	Size	Gram Weight*	Palm Thickness	Finger Thickness	Texture	Quantity	Skid Quantity
GNEP-SM-1	Small	4.0	4.0 mil +/- 0.5 mil	4.5 mil +/- 0.5 mil	Fingertip	100 bx/ 10 cs	48
GNEP-MD-1	Medium	4.5					
GNEP-LG-1	Large	5.0					
GNEP-XL-1	X-Large	5.5					

- 100% Latex and PFAS Free
  - Textured fingertips for improved grip
- \* Glove weights may vary (+/-0.3 grams)

**GNEP-SZ-K/Nitrile/Powder Free/Black**

Item	Size	Gram Weight*	Palm Thickness	Finger Thickness	Texture	Quantity	Skid Quantity
GNEP-SM-K	Small	4.5	4.4 mil +/- 0.5 mil	4.9 mil +/- 0.5 mil	Fingertip	100 bx/ 10 cs	48
GNEP-MD-K	Medium	5.0					
GNEP-LG-K	Large	5.5					
GNEP-XL-K	X-Large	6.0					

- 100% Latex and PFAS Free
  - Textured fingertips for improved grip
- \* Glove weights may vary (+/-0.3 grams)

**GNEP-SZ-5-T8/Nitrile/12"/Powder Free/Blue**

Item	Size	Gram Weight*	Palm Thickness	Finger Thickness	Texture	Quantity	Skid Quantity
GNEP-SM-5-T8	Small	9.5	7.3 mil +/- 0.5 mil	7.8 mil +/- 0.5 mil	Fingertip	50 bx/ 10 cs	48
GNEP-MD-5-T8	Medium	10.5					
GNEP-LG-5-T8	Large	11.5					
GNEP-XL-5-T8	X-Large	12.5					
GNEP-2X-5-T8	2X-Large	13.0					

- 100% Latex and PFAS Free
  - Textured fingertips for improved grip
- \* Glove weights may vary (+/-0.5 grams)



ALL SAFETY ZONE GLOVES COMPLY WITH THE FFDC A FOR FOOD CONTACT AND ARE PHTHALATE FREE

## What are the Pros and Cons of Vinyl Single Use Gloves?

### Pros:

- 100% Synthetic / 100% Latex Free / Zero natural proteins
- Has great shelf life and if stored properly are good for over 10 years
- Inexpensive hand protection

### Cons:

- They have limited stretch
- Poor elasticity/elongation
- Poor tensile strength

## Vinyl Gloves are 100 % Allergen Free



**100 % Latex Free**



### 100% PFAS Free

PFAS also known as Per- and polyfluoroalkyl substances are human-made chemicals used in both consumer and industrial products. PFAS chemicals do not easily breakdown in the environment. Exposure to some types of PFAS have been linked to serious health effects. All PPE products manufactured and distributed by Supply Source are PFAS free.



### 100% Phthalate Free

According to the FDA, Phthalates are a group of chemicals used in hundreds of products, such as toys, vinyl flooring and wall covering, detergents, lubricating oils, food packaging, pharmaceuticals, blood bags and tubing, and personal care products, such as nail polish, hair sprays, aftershave lotions, soaps, shampoos, perfumes and other fragrance preparations.

## Federal Food, Drug, and Cosmetic Act (FD&C Act)

The FD&C Act is a set of laws passed by Congress in 1938 giving authority to the U.S. Food and Drug Administration (FDA) to oversee the safety of food, drugs, and cosmetics. All Safety Zone glove components comply with the provisions of the FD&C Act, which allow repeated use in direct contact with food.

### FDA Rule 110.10 & 177.1950



**Rule 110.10** Nitrile gloves sold by The Safety Zone meet the requirements for handling of human food in both the manufacturing and packaging phases of production.

**Rule 177.1950** Nitrile gloves sold by The Safety Zone contain chloride-ethylene co-polymers, which may be safely used for repeated use when coming into contact with food.

**Disposable Vinyl gloves have limitations compared to other glove materials like nitrile or latex. They are generally less resistant to chemicals and punctures, making them more suitable for low-risk applications. Additionally, individuals with latex allergies often prefer vinyl gloves as an alternative. Common industry uses are:**

**Medical and Healthcare:** Vinyl gloves are frequently used in medical and healthcare facilities, including hospitals, clinics, and doctor's offices. They offer protection for healthcare professionals during examinations, minor procedures, and handling of patients, while also minimizing the risk of cross-contamination.

**Food Service and Handling:** Vinyl gloves are widely used in the food service industry, particularly in food preparation and handling. They provide a barrier between the hands and food products, ensuring hygiene and preventing the spread of bacteria. Vinyl gloves are commonly used in restaurants, cafeterias, catering services, and food processing plants.

**Childcare and Daycare Centers:** Vinyl gloves are used in childcare facilities to maintain cleanliness and hygiene while handling diaper changes, feeding, and other tasks involving infants and toddlers. They help reduce the risk of transmitting germs and keep both children and caregivers safe.

**Manufacturing and Industrial Applications:** Vinyl gloves can be found in manufacturing and industrial settings where workers need hand protection against non-hazardous substances, dust, or dirt. They are commonly used in assembly lines, electronics manufacturing, packaging, and light-duty tasks.

# DISPOSABLE GLOVES - VINYL



## GVP9-SZ-HH/Vinyl/Powder Free/Clear

Item	Size	Gram Weight*	Palm Thickness	Finger Thickness	Texture	Quantity	Skid Quantity
GVP9-SM-HH	Small	3.8	2.4 mil +/- 0.8 mil	2.8 mil +/- 0.8 mil	Smooth	100 bx/ 10 cs	68
GVP9-MD-HH	Medium	4.3					
GVP9-LG-HH	Large	4.8					
GVP9-XL-HH	X-Large	5.3					

- 100% Latex and PFAS Free
- \* Glove weights may vary (+/-0.3 grams)



## GVP9-SZ-1/Vinyl/Powder Free/Clear

Item	Size	Gram Weight*	Palm Thickness	Finger Thickness	Texture	Quantity	Skid Quantity
GVP9-SM-1	Small	4.3	3.2 mil +/- 0.8 mil	3.6 mil +/- 0.8 mil	Smooth	100 bx/ 10 cs	68
GVP9-MD-1	Medium	4.8					
GVP9-LG-1	Large	5.3					
GVP9-XL-1	X-Large	5.8					

- 100% Latex and PFAS Free
- \* Glove weights may vary (+/-0.3 grams)



## GVP9-SZ-1-SY/Synthetic/Powder Free/Natural

Item	Size	Gram Weight*	Palm Thickness	Finger Thickness	Texture	Quantity	Skid Quantity
GVP9-SM-1-SY	Small	4.0	3.0 mil +/- 0.8 mil	3.4 mil +/- 0.8 mil	Smooth	100 bx/ 10 cs	68
GVP9-MD-1-SY	Medium	4.5					
GVP9-LG-1-SY	Large	5.0					
GVP9-XL-1-SY	X-Large	5.5					

- 100% Latex and PFAS Free
- \* Glove weights may vary (+/-0.3 grams)





## GVP9-SZ-1C/Vinyl/Powder Free/Clear



Item	Size	Gram Weight*	Palm Thickness	Finger Thickness	Texture	Quantity	Skid Quantity
GVP9-SM-1C	Small	4.5	4.0 mil +/- 0.8 mil	4.8 mil +/- 0.8 mil	Smooth	100 bx/ 10 cs	52
GVP9-MD-1C	Medium	5.5					
GVP9-LG-1C	Large	6.5					
GVP9-XL-1C	X-Large	7.0					
GVP9-2X-1C	2X-Large	6.5					

- 100% Latex and PFAS Free
- \* Glove weights may vary (+/-0.3 grams)



## GVP9-SZ-1-BL/Vinyl/Powder Free/Blue



Item	Size	Gram Weight*	Palm Thickness	Finger Thickness	Texture	Quantity	Skid Quantity
GVP9-SM-1-BL	Small	4.3	3.2 mil +/- 0.8 mil	3.6 mil +/- 0.8 mil	Smooth	100 bx/ 10 cs	64
GVP9-MD-1-BL	Medium	4.8					
GVP9-LG-1-BL	Large	5.3					
GVP9-XL-1-BL	X-Large	5.8					
GVP9-2X-1-BL	2X-Large	6.5					

- 100% Latex and PFAS Free
- \* Glove weights may vary (+/-0.3 grams)



## GVP9-SZ-2-BL/Vinyl/Powder Free/Blue



Item	Size	Gram Weight*	Palm Thickness	Finger Thickness	Texture	Quantity	Skid Quantity
GVP9-SM-2-BL	Small	3.8	3.2 mil +/- 0.8 mil	3.6 mil +/- 0.8 mil	Smooth	200bx/ 10 cs	64
GVP9-MD-2-BL	Medium	4.3					
GVP9-LG-2-BL	Large	4.8					
GVP9-XL-2-BL	X-Large	5.3					

- 100% Latex and PFAS Free
- \* Glove weights may vary (+/-0.3 grams)



ALL SAFETY ZONE GLOVES COMPLY WITH THE FFDC A FOR FOOD CONTACT AND ARE PHTHALATE FREE

# DISPOSABLE GLOVES - VINYL



## GVP9-SZ-1C-BL/Vinyl/Powder Free/Blue

Item	Size	Gram Weight*	Palm Thickness	Finger Thickness	Texture	Quantity	Skid Quantity
GVP9-SM-1C-BL	Small	4.5	4.0 mil +/- 0.8 mil	4.8 mil +/- 0.8 mil	Smooth	100 bx/ 10 cs	52
GVP9-MD-1C-BL	Medium	5.5					
GVP9-LG-1C-BL	Large	6.5					
GVP9-XL-1C-BL	X-Large	7.0					
GVP9-2X-1C-BL	2X-Large	7.5					

- 100% Latex and PFAS Free
- \* Glove weights may vary (+/-0.3 grams)



## GVP9-SZ-1-SYBL/Synthetic/Powder Free/Blue

Item	Size	Gram Weight*	Palm Thickness	Finger Thickness	Texture	Quantity	Skid Quantity
GVP9-SM-1-SYBL	Small	4.5	3.6 mil +/- 0.8 mil	4.0 mil +/- 0.8 mil	Smooth	100 bx/ 10 cs	64
GVP9-MD-1-SYBL	Medium	5.0					
GVP9-LG-1-SYBL	Large	5.5					
GVP9-XL-1-SYBL	X-Large	6.0					

- 100% Latex and PFAS Free
- \* Glove weights may vary (+/-0.3 grams)



## GVP9-SZ-1C-K/Vinyl/Powder Free/Black

Item	Size	Gram Weight*	Palm Thickness	Finger Thickness	Texture	Quantity	Skid Quantity
GVP9-SM-1C-K	Small	4.0	3.0 mil +/- 0.8 mil	3.4 mil +/- 0.8 mil	Smooth	100 bx/ 10 cs	52
GVP9-MD-1C-K	Medium	4.5					
GVP9-LG-1C-K	Large	5.0					
GVP9-XL-1C-K	X-Large	5.5					

- 100% Latex and PFAS Free
- \* Glove weights may vary (+/-0.3 grams)



ALL SAFETY ZONE GLOVES COMPLY WITH THE FFDCA FOR FOOD CONTACT AND ARE PHTHALATE FREE

### GVDR-SZ-HH/Vinyl/Powdered/Clear



Item	Size	Gram Weight*	Palm Thickness	Finger Thickness	Texture	Quantity	Skid Quantity
GVDR-SM-HH	Small	3.8	2.8 mil +/- 0.8 mil	3.2 mil +/- 0.8 mil	Smooth	100 bx/ 10 cs	68
GVDR-MD-HH	Medium	4.3					
GVDR-LG-HH	Large	4.8					
GVDR-XL-HH	X-Large	5.3					

- 100% Latex and PFAS Free
- \* Glove weights may vary (+/-0.3 grams)



### GVDR-SZ-1/Vinyl/Powdered/Clear



Item	Size	Gram Weight*	Palm Thickness	Finger Thickness	Texture	Quantity	Skid Quantity
GVDR-SM-1	Small	4.3	3.2 mil +/- 0.8 mil	3.6 mil +/- 0.8 mil	Smooth	100 bx/ 10 cs	64
GVDR-MD-1	Medium	4.8					
GVDR-LG-1	Large	5.3					
GVDR-XL-1	X-Large	5.8					

- 100% Latex and PFAS Free
- \* Glove weights may vary (+/-0.3 grams)



### GVDR-SZ-1C/Vinyl/Powdered/Clear



Item	Size	Gram Weight*	Palm Thickness	Finger Thickness	Texture	Quantity	Skid Quantity
GVDR-SM-1C	Small	4.5	4.0 mil +/- 0.8 mil	5.0 mil +/- 0.8 mil	Smooth	100 bx/ 10 cs	52
GVDR-MD-1C	Medium	5.5					
GVDR-LG-1C	Large	6.5					
GVDR-XL-1C	X-Large	7.0					
GVDR-2X-1C	2X-Large	6.5					

- 100% Latex and PFAS Free
- \* Glove weights may vary (+/-0.3 grams)



### GVDL-SZ-1/Vinyl/Powdered/Blue



Item	Size	Gram Weight*	Palm Thickness	Finger Thickness	Texture	Quantity	Skid Quantity
GVDL-SM-1	Small	4.3	3.2 mil +/- 0.8 mil	3.6 mil +/- 0.8 mil	Smooth	100 bx/ 10 cs	64
GVDL-MD-1	Medium	4.8					
GVDL-LG-1	Large	5.3					
GVDL-XL-1	X-Large	5.8					

- 100% Latex and PFAS Free
- \* Glove weights may vary (+/-0.3 grams)



# DISPOSABLE GLOVES - VINYL



## GVDL-SZ-1C/Vinyl/Powdered/Blue

Item	Size	Gram Weight*	Palm Thickness	Finger Thickness	Texture	Quantity	Skid Quantity
GVDL-SM-1C	Small	4.5	4.0 mil +/- 0.8 mil	4.8 mil +/- 0.8 mil	Smooth	100 bx/ 10 cs	52
GVDL-MD-1C	Medium	5.5					
GVDL-LG-1C	Large	6.5					
GVDL-XL-1C	X-Large	7.0					

- 100% Latex and PFAS Free
- \* Glove weights may vary (+/-0.3 grams)



## GVP9-SZ-1C-SY/Synthetic/Powdered/Natural



Item	Size	Gram Weight*	Palm Thickness	Finger Thickness	Texture	Quantity	Skid Quantity
GVP9-SM-1C-SY	Small	4.5	4.0 mil +/- 0.8 mil	4.4 mil +/- 0.5 mil	Smooth	100 bx/ 10 cs	52
GVP9-MD-1C-SY	Medium	5.5					
GVP9-LG-1C-SY	Large	6.5					
GVP9-XL-1C-SY	X-Large	7.0					
GVP9-2X-1C-SY	2X-Large	7.8					

- 100% Latex and PFAS Free
- \* Glove weights may vary (+/-0.3 grams)



# DISPOSABLE GLOVES - VINYL - MEDICAL GRADE



## GVEP-SZ-1C/Vinyl/Powder Free/Clear

Item	Size	Gram Weight*	Palm Thickness	Finger Thickness	Texture	Quantity	Skid Quantity
GVEP-SM-1C	Small	4.5	4.0 mil +/- 0.8 mil	4.4 mil +/- 0.8 mil	Smooth	100 bx/ 10 cs	60
GVEP-MD-1C	Medium	5.0					
GVEP-LG-1C	Large	5.5					
GVEP-XL-1C	X-Large	6.0					

- 100% Latex and PFAS Free
- Examination gloves
- \* Glove weights may vary (+/-0.3 grams)



ALL SAFETY ZONE GLOVES COMPLY WITH THE FFCA FOR FOOD CONTACT AND ARE PHTHALATE FREE



## What are the Pros and Cons of Latex Single Use Gloves?

### Pros:

- Extremely flexible with superior stretch called elongation
- Very comfortable fit with great grip
- Holds up very well to solvents like acetone

### Cons:

- Contains natural proteins that some people are allergic to and in rare cases can cause anaphylactic shock, which can be life threatening
- People can develop sensitivity the more they're exposed to it
- Shorter shelf life of approximately two years and dries out over time
- Petroleum products like oil and gas have fast permeation and degradation



### 100% PFAS Free

PFAS also known as Per- and polyfluoroalkyl substances are human-made chemicals used in both consumer and industrial products. PFAS chemicals do not easily breakdown in the environment. Exposure to some types of PFAS have been linked to serious health effects. All PPE products manufactured and distributed by Supply Source are PFAS free.



### 100% Phthalate Free

According to the FDA, Phthalates are a group of chemicals used in hundreds of products, such as toys, vinyl flooring and wall covering, detergents, lubricating oils, food packaging, pharmaceuticals, blood bags and tubing, and personal care products, such as nail polish, hair sprays, aftershave lotions, soaps, shampoos, perfumes and other fragrance preparations.

# DISPOSABLE GLOVES - LATEX

## Federal Food, Drug, and Cosmetic Act (FD&C Act)

The FD&C Act is a set of laws passed by Congress in 1938 giving authority to the U.S. Food and Drug Administration (FDA) to oversee the safety of food, drugs, and cosmetics. All Safety Zone glove components comply with the provisions of the FD&C Act, which allow repeated use in direct contact with food.

## FDA Rule 110.10 & 177.1950



**Rule 110.10** Nitrile gloves sold by The Safety Zone meet the requirements for handling of human food in both the manufacturing and packaging phases of production.

**Rule 177.1950** Nitrile gloves sold by The Safety Zone contain chloride-ethylene co-polymers, which may be safely used for repeated use when coming into contact with food.

**Disposable latex gloves have a wide range of common uses across various industries and everyday situations. Here are some of the most common applications:**

**Medical and Healthcare:** Latex gloves are extensively used in medical and healthcare settings to maintain hygiene and prevent the spread of infections. Doctors, nurses, and other healthcare professionals wear them during examinations, surgeries, and other medical procedures.

**First Aid and Emergency Services:** Latex gloves are an essential component of first aid kits and are used by first responders, paramedics, and emergency medical technicians (EMTs) to protect themselves and provide hygienic care during medical emergencies.

**Painting and DIY Projects:** When engaging in painting, DIY projects, or any tasks involving chemicals, latex gloves provide protection against paint, solvents, stains, and other substances that could irritate or harm the skin.

**Automotive and Mechanics:** In automotive workshops and mechanic garages, latex gloves are commonly used to protect hands from chemicals, oils, greases, and other substances encountered during vehicle repairs and maintenance.

**Childcare and Babysitting:** Latex gloves may be used by childcare providers, babysitters, and daycare staff when changing diapers, handling bodily fluids, or administering first aid to young children. They help maintain cleanliness and minimize the risk of contamination.

## GRPR-SZ-1-T/Latex/Powder Free/Natural



Item	Size	Gram Weight*	Palm Thickness	Finger Thickness	Texture	Quantity	Skid Quantity
GRPR-SM-1-T	Small	5.0	4.0 mil +/- 0.5 mil	5.0 mil +/- 0.5 mil	Smooth	100 bx/ 10 cs	60
GRPR-MD-1-T	Medium	5.4					
GRPR-LG-1-T	Large	5.9					
GRPR-XL-1-T	X-Large	6.5					
GRPR-2X-1-T	2X-Large	7.2					

- 100% PFAS Free
- \* Glove weights may vary (+/-0.3 grams)



## GRPR-SZ-1-T8/Latex/Powder Free/Natural



Item	Size	Gram Weight*	Palm Thickness	Finger Thickness	Texture	Quantity	Skid Quantity
GRPR-SM-1-T8	Small	9.8	8.0 mil +/- 0.5 mil	10.0 mil +/- 0.5 mil	Smooth	100 bx/ 10 cs	40
GRPR-MD-1-T8	Medium	10					
GRPR-LG-1-T8	Large	11					
GRPR-XL-1-T8	X-Large	12					

- 100% PFAS Free
- \* Glove weights may vary (+/-0.3 grams)



## GRHL-SZ-5M-P/Latex/Powder Free/Blue/12"/Double Chlorinated



Item	Size	Gram Weight*	Palm Thickness	Finger Thickness	Texture	Quantity	Skid Quantity
GRHL-SM-5M-P	Small	17.5	13.0 mil +/- 0.5 mil	15.0 mil +/- 0.5 mil	Smooth	50 bx/ 10 cs	40
GRHL-MD-5M-P	Medium	18.5					
GRHL-LG-5M-P	Large	20					
GRHL-XL-5M-P	X-Large	21.5					
GRHL-2X-5M-P	2X-Large	23					

- 100% PFAS Free
- \* Glove weights may vary (+/-0.3 grams)



# DISPOSABLE GLOVES - LATEX

## GRDR-SZ-1-T/Latex/Powdered/Natural



Item	Size	Gram Weight*	Palm Thickness	Finger Thickness	Texture	Quantity	Skid Quantity
GRDR-XS-1-T	X-Small	5.0	4.0 mil +/- 0.5 mil	5.3 mil +/- 0.5 mil	Smooth	100 bx/ 10 cs	60
GRDR-SM-1-T	Small	5.4					
GRDR-MD-1-T	Medium	5.9					
GRDR-LG-1-T	Large	6.5					

- 100% PFAS Free
- \* Glove weights may vary (+/-0.3 grams)



# MEDICAL GRADE LATEX

## GREP-SZ-1/Latex/Powder Free/Natural



Item	Size	Gram Weight*	Palm Thickness	Finger Thickness	Texture	Quantity	Skid Quantity
GREP-SM-1	Small	5.2	4.5 mil +/- 0.5 mil	5.0 mil +/- 0.5 mil	Smooth	100 bx/ 10 cs	60
GREP-MD-1	Medium	5.8					
GREP-LG-1	Large	6.1					
GREP-XL-1	X-Large	6.7					

- 100% PFAS Free
- \* Glove weights may vary (+/-0.3 grams)



ALL SAFETY ZONE GLOVES COMPLY WITH THE FFDC A FOR FOOD CONTACT AND ARE PHTHALATE FREE

## History of the Latex Glove

Latex was the first material used to make gloves.

In 1894, William Stewart Halsted at Johns Hopkins is widely credited as the first to develop and introduce rubber surgical gloves in the United States.

Latex is harvested from rubber trees by scoring the bark and collecting the milky latex in a very labor intensive process.



Rubber trees take 6-8 years to reach maturity and need to be grown near the equator and are most prevalent in Malaysia, Indonesia, Thailand and Vietnam.

The constant scoring of the bark shortens their life while palm oil trees compete for the same land and require less manual labor to harvest reducing the supply.



## What are the Pros and Cons of Poly Single Use Gloves?

### Pros:

- Inexpensive food handling glove
- 100% Synthetic / 100% Latex Free / Zero natural proteins
- Has great shelf life and if stored properly are good for over 10 years

### Cons:

- Poor elasticity/elongation
- Poor tensile strength
- Lose fitting and baggy
- Have a low melting point

## Polyethylene Gloves are 100 % Allergen Free



**100 % Latex Free**



**100 % Silicone Free**

### 100% PFAS Free



PFAS also known as Per- and polyfluoroalkyl substances are human-made chemicals used in both consumer and industrial products. PFAS chemicals do not easily breakdown in the environment. Exposure to some types of PFAS have been linked to serious health effects. All PPE products manufactured and distributed by Supply Source are PFAS free.

### 100% Phthalate Free



According to the FDA, Phthalates are a group of chemicals used in hundreds of products, such as toys, vinyl flooring and wall covering, detergents, lubricating oils, food packaging, pharmaceuticals, blood bags and tubing, and personal care products, such as nail polish, hair sprays, aftershave lotions, soaps, shampoos, perfumes and other fragrance preparations.

# DISPOSABLE GLOVES - POLY

## Federal Food, Drug, and Cosmetic Act (FD&C Act)

The FD&C Act is a set of laws passed by Congress in 1938 giving authority to the U.S. Food and Drug Administration (FDA) to oversee the safety of food, drugs, and cosmetics. All Safety Zone glove components comply with the provisions of the FD&C Act, which allow repeated use in direct contact with food.

## FDA Rule 110.10 & 177.1950



**Rule 110.10** Nitrile gloves sold by The Safety Zone meet the requirements for handling of human food in both the manufacturing and packaging phases of production.

**Rule 177.1950** Nitrile gloves sold by The Safety Zone contain chloride-ethylene co-polymers, which may be safely used for repeated use when coming into contact with food.

**It is important to note that polyethylene gloves are not suitable for high-risk or medical procedures that require sterile conditions or protection against hazardous substances. In those cases, specialized gloves made of different materials may be required. Here are some common uses of disposable poly gloves:**

**Food Handling:** Polyethylene gloves are frequently used in food preparation and handling to maintain hygiene and prevent cross-contamination. They are suitable for tasks such as food assembly, packaging, and handling raw ingredients.

**Beauty and Salon Services:** In beauty salons and spas, polyethylene gloves are used during various treatments like hair coloring, perming, and applying chemical-based products. They help protect the hands of beauticians and clients from direct contact with potentially irritating or staining substances.

**General Household Tasks:** Polyethylene gloves are commonly used for various household tasks like cleaning, gardening, pet care, and handling messy substances, such as paint or adhesives.

**Veterinary Clinics:** Veterinarians and animal care professionals use disposable polyethylene gloves when examining and treating animals. These gloves help maintain cleanliness, prevent the spread of pathogens, and protect against potential allergic reactions.

### GDPE-SZ/High Density Poly/Powder Free/Clear



Item	Size	Gram Weight*	Palm Thickness	Finger Thickness	Texture	Quantity	Skid Quantity
GDPE-SM	Small	0.55	0.5 mil +/- 0.2 mil	1.0 mil +/- 0.5 mil	Embossed Grip	100 bx/ 10 bx/ carton/10 cartons/cs	24
GDPE-MD	Medium	0.58					
GDPE-LG	Large	0.60					
GDPE-XL	X-Large	0.65					

- 100% Phthalate Free
  - 100% Latex and Silicone Free
  - Textured fingertips for improved grip
- \* Glove weights may vary (+/-0.3 grams)



### GDPE-SZ-5/High Density Poly/Powder Free/Clear



Item	Size	Gram Weight*	Palm Thickness	Finger Thickness	Texture	Quantity	Skid Quantity
GDPE-SM-5	Small	0.55	0.5 mil +/- 0.2 mil	1.0 mil +/- 0.5 mil	Embossed Grip	500 bx/ 2 bx/ carton/10 cartons/cs	24
GDPE-MD-5	Medium	0.58					
GDPE-LG-5	Large	0.60					
GDPE-XL-5	X-Large	1.65					

- 100% Phthalate Free
  - 100% Latex and Silicone Free
  - Textured fingertips for improved grip
- \* Glove weights may vary (+/-0.3 grams)



### GDCP-SZ/Clear Cast Poly/Powder Free/Clear



Item	Size	Gram Weight*	Palm Thickness	Finger Thickness	Texture	Quantity	Skid Quantity
GDCP-SM	Small	1.7	1.2 mil +/- 0.5 mil	0.06 mil +/- 0.01 mil	Raised Textured Grip	500 bx/ 2 bx/ carton/10 cartons/cs	80
GDCP-MD	Medium	1.8					
GDCP-LG	Large	1.9					
GDCP-XL	X-Large	2.0					

- 100% Phthalate Free
  - 100% Latex and Silicone Free
  - Textured fingertips for improved grip
- \* Glove weights may vary (+/-0.3 grams)



# DISPOSABLE GLOVES - POLY



## GDCP-HC/Clear Cast Poly/Powder Free/Clear

Item	Size	Gram Weight*	Palm Thickness	Finger Thickness	Texture	Quantity	Skid Quantity
GDCP-HC	Large	1.44	0.7 mil +/- 0.2 mil	0.06 mil +/- 0.01 mil	Raised Textured Grip	50 header/ 20 headers/cs	80

- 100% Phthalate Free
- 100% Latex and Silicone Free
- Textured fingertips for improved grip
- Attached header card for convenient hanging

\* Glove weights may vary (+/-0.3 grams)



## GDSH-SZ/Stretch Hybrid Poly/Powder Free/Clear

Item	Size	Gram Weight*	Palm Thickness	Finger Thickness	Texture	Quantity	Skid Quantity
GDSH-SM	Small	1.8	2.1 mil +/- 0.5 mil	2.5 mil +/- 0.5 mil	Embossed Grip	100 bx/10 cs	112
GDSH-MD	Medium	1.9					
GDSH-LG	Large	2.0					
GDSH-XL	X-Large	2.1					

- 100% Phthalate Free
- 100% Latex and Silicone Free
- Textured fingertips for improved grip

\* Glove weights may vary (+/-0.3 grams)



## GDSH-SZ-BL/Stretch Hybrid Poly/Powder Free/Blue

Item	Size	Gram Weight*	Palm Thickness	Finger Thickness	Texture	Quantity	Skid Quantity
GDSH-SM-BL	Small	1.8	2.0 mil +/- 0.5 mil	2.5 mil +/- 0.5 mil	Embossed Grip	100 bx/10 cs	112
GDSH-MD-BL	Medium	1.9					
GDSH-LG-BL	Large	2.0					
GDSH-XL-BL	X-Large	2.1					

- 100% Phthalate Free
- 100% Latex and Silicone Free
- Textured fingertips for improved grip

\* Glove weights may vary (+/-0.3 grams)



ALL SAFETY ZONE GLOVES COMPLY WITH THE FFDCA FOR FOOD CONTACT AND ARE PHTHALATE FREE

## GDPE-LG-18/18" High Density Poly/Powder Free/Clear

Item	Size	Gram Weight*	Palm Thickness	Finger Thickness	Texture	Quantity	Skid Quantity
GDPE-LG-18	18"	1.4	0.5 mil +/- 0.2 mil	1.0 mil +/- 0.5 mil	Embossed Grip	350 bx/ 10 cs	64

- 100% Phthalate Free
- 100% Latex and Silicone Free
- Textured fingertips for improved grip

\* Glove weights may vary (+/-0.3 grams)



## GDPE-LG-35/35" High Density Poly/Powder Free/Clear

Item	Size	Gram Weight*	Palm Thickness	Finger Thickness	Texture	Quantity	Skid Quantity
GDPE-LG-35	35"	9.5	1.0 mil +/- 0.5 mil	2.0 mil +/- 0.5 mil	Embossed Grip	100 bx/ 10 cs	27

- 100% Phthalate Free
- 100% Latex and Silicone Free
- Textured fingertips for improved grip

\* Glove weights may vary (+/-0.3 grams)



ALL SAFETY ZONE GLOVES COMPLY WITH THE FFDCA FOR FOOD CONTACT AND ARE PHTHALATE FREE

# REUSABLE GLOVES



# CHEMICAL & FLOCK LINED GLOVES

SAFETY ZONE™

## GRFY-SZ-2E/12" Yellow Flock Lined Latex



Item	Size	Palm Thickness	Texture	Quantity	Skid Quantity
GRFY-SM-2E	Small	12 MIL	Fish Scale Grip	One Pair/bg 12 DZ/cs	40
GRFY-MD-2E	Medium				
GRFY-LG-2E	Large				
GRFY-XL-2E	X-Large				

- 100% Phthalate Free
- Fish scale texture for improved grip



## GRFY-SZ-1B/12" Yellow Flock Lined Latex /Bulk Packed



Item	Size	Palm Thickness	Texture	Quantity	Skid Quantity
GRFY-SM-1B	Small	16 MIL	Fish Scale Grip	One DZ/bg 10 DZ/cs	44
GRFY-MD-1B	Medium				
GRFY-LG-1B	Large				
GRFY-XL-1B	X-Large				

- 100% Phthalate Free
- Fish scale texture for improved grip



## GRFY-SZ-1C/12" Yellow Flock Lined Latex /Bulk Packed



Item	Size	Palm Thickness	Texture	Quantity	Skid Quantity
GRFY-SM-1C	Small	16 MIL	Fish Scale Grip	One Pair/bg 10 DZ/cs	44
GRFY-MD-1C	Medium				
GRFY-LG-1C	Large				
GRFY-XL-1C	X-Large				
GRFY-2X-1C	Large				

- 100% Phthalate Free
- Fish scale texture for improved grip



# CHEMICAL & FLOCK LINED GLOVES

## GRFY-SZ-1S/12" Yellow Flock Lined Latex



Item	Size	Palm Thickness	Texture	Quantity	Skid Quantity
GRFY-SM-1S	Small	18 MIL	Fish Scale Grip	One Pair/bg 10 DZ/cs	44
GRFY-MD-1S	Medium				
GRFY-LG-1S	Large				
GRFY-XL-1S	X-Large				

- 100% Phthalate Free
- Pinked Cuff
- Fish scale texture for improved grip



## GRFY-SZ-2T-R/C/12" Yellow Chlorinated Flock Lined Latex



Item	Size	Palm Thickness	Texture	Quantity	Skid Quantity
GRFY-SM-2T-R/C	Small	20 MIL	Recessed Diamond Grip	One Pair/bg 12 DZ/cs	44
GRFY-MD-2T-R/C	Medium				
GRFY-LG-2T-R/C	Large				
GRFY-XL-2T-R/C	X-Large				

- 100% Phthalate Free
- Fish scale texture for improved grip



ALL SAFETY ZONE GLOVES COMPLY WITH THE FFDCA FOR FOOD CONTACT AND ARE PHTHALATE FREE





### GRFL-SZ-1S/12" Blue Flock Lined Latex

Item	Size	Palm Thickness	Texture	Quantity	Skid Quantity
GRFL-SM-1S	Small	18 MIL	Fish Scale Grip	One Pair/bg 10 DZ/cs	44
GRFL-MD-1S	Medium				
GRFL-LG-1S	Large				
GRFL-XL-1S	X-Large				

- 100% Phthalate Free
- Textured fingertips for improved grip



### GRFL-SZ-1C/12" Blue Flock Lined Latex

Item	Size	Palm Thickness	Texture	Quantity	Skid Quantity
GRFL-SM-1C	Small	16 MIL	Diamond Grip	One Pair/bg 10 DZ/cs	44
GRFL-MD-1C	Medium				
GRFL-LG-1C	Large				
GRFL-XL-1C	X-Large				

- 100% Phthalate Free
- Textured fingertips for improved grip



### GRFL-SZ-1SF/12" Blue Neoprene Over Yellow Flock Lined Latex

Item	Size	Palm Thickness	Texture	Quantity	Skid Quantity
GRFL-SM-1SF	Small	28 MIL	Diamond Grip	One Pair/bg 10 DZ/cs	44
GRFL-MD-1SF	Medium				
GRFL-LG-1SF	Large				
GRFL-XL-1SF	X-Large				

- 100% Phthalate Free
- Textured fingertips for improved grip



# CHEMICAL & FLOCK LINED GLOVES

## GRFO-SZ-1SF/12" Orange Flock Lined Neoprene Latex



Item	Size	Palm Thickness	Texture	Quantity	Skid Quantity
GRFY-SM-1SF	Small	28 MIL	Fish Scale Grip	One Pair/bg 10 DZ/cs	44
GRFY-MD-1SF	Medium				
GRFY-LG-1SF	Large				
GRFY-XL-1SF	X-Large				

- 100% Phthalate Free
- Straight Cuff
- Textured fingertips for improved grip



## GNGF-SZ-15C/13" Standard Green Flock Lined Nitrile



Item	Size	Palm Thickness	Texture	Quantity	Skid Quantity
GNGF-SM-15C	Small	15 MIL	Raised Diamond Grip	One Pair/bg 12 DZ/cs	44
GNGF-MD-15C	Medium				
GNGF-LG-15C	Large				
GNGF-XL-15C	X-Large				

- 100% Phthalate Free
- Straight Cuff
- Textured fingertips for improved grip



## GNGF-SZ-15/13" Premium Green Flock Lined Nitrile



Item	Size	Palm Thickness	Texture	Quantity	Skid Quantity
GNGF-SM-15	Small	15 MIL	Raised Diamond Grip	One Pair/bg 12 DZ/cs	44
GNGF-MD-15	Medium				
GNGF-LG-15	Large				
GNGF-XL-15	X-Large				
GNGF-2X-15	Large				

- 100% Phthalate Free
- Straight Cuff
- Textured fingertips for improved grip



ALL SAFETY ZONE GLOVES COMPLY WITH THE FFDCA FOR FOOD CONTACT AND ARE PHTHALATE FREE

### GNGU-SZ-11C/13" Standard Green Unlined Nitrile



Item	Size	Palm Thickness	Texture	Quantity	Skid Quantity
GNGU-SM-11C	Small	11 MIL	Raised Diamond Grip	One Pair/bg 12 DZ/cs	44
GNGU-MD-11C	Medium				
GNGU-LG-11C	Large				
GNGU-XL-11C	X-Large				

- 100% Phthalate Free
- Textured fingertips for improved grip



### GNGU-SZ-11C/13" Premium Green Unlined Nitrile



Item	Size	Palm Thickness	Texture	Quantity	Skid Quantity
GNGU-SM-11	Small	11 MIL	Raised Diamond Grip	One Pair/bg 12 DZ/cs	44
GNGU-MD-11	Medium				
GNGU-LG-11	Large				
GNGU-XL-11	X-Large				
GNGU-2X-11	2X-Large				

- 100% Phthalate Free
- Textured fingertips for improved grip



### GNGU-SZ-22-18/18" Green Unlined Nitrile



Item	Size	Palm Thickness	Texture	Quantity	Skid Quantity
GNGU-MF-22-18	Medium	22 MIL	Raised Diamond Grip	One Pair/bg 3 DZ/cs	44
GNGU-LG-22-18	Large				
GNGU-XL-22-18	X-Large				
GNGU-2X-22-18	2X-Large				

- 100% Phthalate Free
- Textured fingertips for improved grip



# CHEMICAL & FLOCK LINED GLOVES

## GRCA-SZ-1SF/12" Orange Flock Lined Neoprene Latex



Item	Size	Palm Thickness	Texture	Quantity	Skid Quantity
GRCA-SM-1SF	Small	18 MIL	Fish Scale Grip	One Pair/bg 10 DZ/cs	44
GRCA-MD-1SF	Medium				
GRCA-LG-1SF	Large				
GRCA-XL-1SF	X-Large				

- 100% Phthalate Free
- Straight Cuff
- Textured fingertips for improved grip



## GRCL-SZ-1SF/13" Green Flock Lined Nitrile



Item	Size	Palm Thickness	Texture	Quantity	Skid Quantity
GRCL-SM-15C	Small	15 MIL	Raised Diamond Grip	One Pair/bg 12 DZ/cs	44
GRCL-MD-15C	Medium				
GRCL-LG-15C	Large				
GRCL-XL-15C	X-Large				

- 100% Phthalate Free
- Straight Cuff
- Textured fingertips for improved grip



## GRBU-SZ-6T/16" Black Heavy Duty Latex Pot Scrubber



Item	Size	Palm Thickness	Texture	Quantity	Skid Quantity
GRBU-LG-15	Large	40 MIL	Raised Diamond Grip	One Pair/bg 6 DZ/cs	44
GRBU-XL-15	X-Large				

- 100% Phthalate Free
- Straight Cuff
- Textured fingertips for improved grip



ALL SAFETY ZONE GLOVES COMPLY WITH THE FFDCA FOR FOOD CONTACT AND ARE PHTHALATE FREE

## GRFB-SZ-1S/12" Black Flock Lined Neoprene Latex Blend



Item	Size	Palm Thickness	Texture	Quantity	Skid Quantity
GRFB-SM-11C	Small	28 MIL	Fish Scale Grip	One Pair/bg 10 DZ/cs	44
GRFB-MD-11C	Medium				
GRFB-LG-11C	Large				
GRFB-XL-11C	X-Large				

- 100% Phthalate Free
- Textured fingertips for improved grip



## COATED KNIT GLOVES

### GSPC-SZ-2C/Blue/Natural Coated Knit Gloves



Item	Size	Construction	Coating	Quantity	Skid Quantity
GSPC-WM-2C	Women's	Flat Dipped Knit	Latex	18 DZ/cs	16
GSPC-MN-2C	Men's				
GSPC-XL-2C	X-Large				

- Flat dipped knit
- Latex coating
- Smooth grip

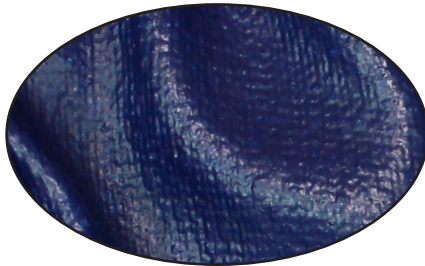

# COATED KNIT GLOVES



## GRSL-SZ/Premium Blue/Gray Coated Knit Gloves

Item	Size	Construction	Coating	Quantity	Skid Quantity
GRSL-SM	Small	Flat Dipped Knit	Latex	6 DZ/cs	36
GRSL-MD	Medium				
GRSL-LG	Large				
GRSL-XL	X-Large				

- Flat dipped knit
- Latex coating
- Crinkle grip

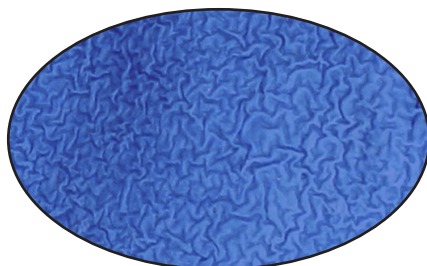

EN388	ANSI	EN 388
2	2	1
ABRASION	CUT	2242



## G-NIDEX-SZ/Black/Gray Coated Knit Gloves

Item	Size	Construction	Coating	Quantity	Skid Quantity
G-NIDEX-SM	Small	Flat Dipped Knit	Nitrile	6 DZ/cs	80
G-NIDEX-MD	Medium				
G-NIDEX-LG	Large				
G-NIDEX-XL	X-Large				
G-NIDEX-2XL	2X-Large				

- Flat dipped knit
- Nitrile coating
- Smooth grip

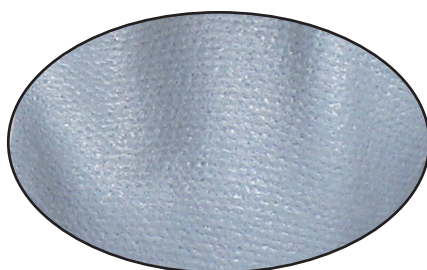

EN388	ANSI	EN388
4	1	1
ABRASION	CUT	4121

ALL SAFETY ZONE GLOVES COMPLY WITH THE FFDCFA FOR FOOD CONTACT AND ARE PHTHALATE FREE



## G-NIDEX-SZ-GF/Gray/White Coated Knit Gloves

Item	Size	Construction	Coating	Quantity	Skid Quantity
G-NIDEX-XS-GF	X-Small	Flat Dipped Knit	Nitrile Foam	6 DZ/cs	80
G-NIDEX-SM-GF	Small				
G-NIDEX-MD-GF	Medium				
G-NIDEX-LG-GF	Large				
G-NIDEX-XL-GF	X-Large				
G-NIDEX-2XL-GF	2X-Large				

- Flat dipped knit
- Foam texture for wet and oily grip

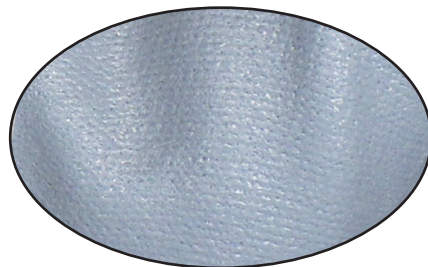

EN388	ANSI	EN388
4	1	4131
ABRASION	CUT	4131

## G-NU-SZ-4-GY-GY/Gray Coated Knit Gloves



Item	Size	Construction	Coating	Quantity	Skid Quantity
G-NU-SZ-4-GY-GY	X-Small	Flat Dipped Knit	Polyurethane	6 DZ/cs	48
G-NU-SM-4-GY-GY	Small				
G-NU-MD-4-GY-GY	Medium				
G-NU-LG-4-GY-GY	Large				
G-NU-XL-4-GY-GY	X-Large				
G-NU-2X-4-GY-GY	2X-Large				

- Flat dipped knit
- Polyurethane coating
- Smooth grip

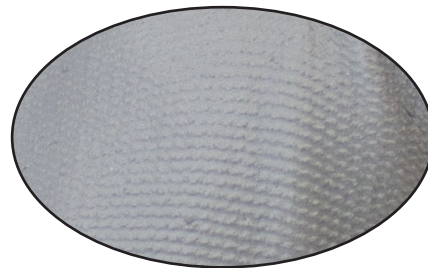

EN388	ANSI	EN388
4	1	4131
ABRASION	CUT	4131

# COATED KNIT GLOVES

## GS13-SZ-CYPU/Gray Coated Knit Gloves



Item	Size	Construction	Coating	Quantity	Skid Quantity
GS13-XS-CYPU	X-Small	Flat Dipped Knit/Cut Resistant	Poly- urethane	72 pr/cs	48
GS13-SM-CYPU	Small				
GS13-MD-CYPU	Medium				
GS13-XLG-CYPU	Large				
GS13-XL-CYPU	X-Large				
GS13-2X-CYPU	2X-Large				

- HPPE knit
- Flat dipped knit
- Polyurethane coating
- Cut resistant
- Smooth grip

EN388	ANSI	EN388
4	A3	4334D
ABRASION	CUT	

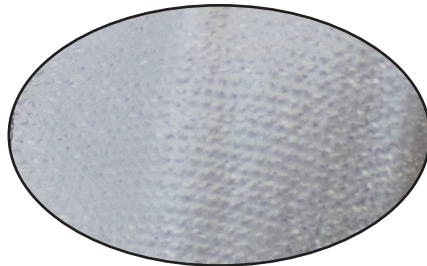

## GNBJ-18-2R/18" Neoprene Fryer Glove



Item	Size	Construction	Coating	Quantity	Skid Quantity
GNBJ-18-2R	One Size	Jersey Lined	Neoprene	25 pr/cs	18

- Black neoprene material
- Rough finish
- Double jersey lining







## GSBS-SZ-2C-20/Premium Cotton Polyester String Knit with 1 Sided PVC Dotted Grip

Item	Size	Construction	Grip	Quantity	Skid Quantity
GSBS-MN-2C-20	Men's Large	Cotton/ Polyester String Knit	Dotted	1DZ/bg 20dz/cs	16
GSBS-WN-2C-20	Women's Medium				

- Cotton/polyester string knit
- 1 Sided PVC dotted grip
- Black/natural color



## GSBD-SZ-2C-20/Cotton Polyester String Knit with 2 Sided PVC Dotted Grip

Item	Size	Construction	Grip	Quantity	Skid Quantity
GSBD-MN-2C-20	Men's Large	Cotton/ polyester String Knit	Dotted	1DZ/bg 20dz/cs	16
GSBD-WN-2C-20	Women's Medium				

- Cotton/polyester string knit
- 2 Sided PVC dotted grip
- Black/natural color





## GSPN-A/White Thermal Knit Liner, Lint Free Inspection Glove

Item	Size	Cuff	Construction	Quantity	Skid Quantity
GSPN-A	One Size	Blue Hemmed	13 Gauge Knit	1 DZ/bag 50dz/cs	18

- 100% Polyester
- Blue Hemmed Cuff
- 13 Gauge Knit Construction



## GILW-SZ-1P/White Light Weight Inspectors Gloves

Item	Size	Cuff	Construction	Quantity	Skid Quantity
GILW-MN-1P	Mens	Unhemmed	2 Piece	100 DZ/cs	16
GILW-WN-1P	Womens				

- 100% Cotton Lisle
- Unhemmed Cuff
- 2 Piece Construction



## GIMW-SZ-1SP/White Medium Weight Inspectors Gloves

Item	Size	Cuff	Construction	Quantity	Skid Quantity
GIMW-MN-1SP	Mens	Unhemmed	2 Piece	100 DZ/cs	48
GIMW-WN-1SP	Womens				

- 100% Cotton Lisle
- Unhemmed Cuff
- 2 Piece Construction



## GSLW-SZ-2P-NRB/Premium Light Weight String Knit Gloves

Item	Size	Construction	Color	Quantity	Skid Quantity
GSLW-MN-2P-NRB	Men's	7 Gauge Blended String Knit	Natural	10 pr bg 40 DZ/cs	16
GSLW-WN-2P-NRB	Women's				

- Cotton Polyester Blend
- 7 Gauge Blended String Knit
- Mens & Women Size Only



## GSLW-SZ-2C-NRB/Standard Light Weight String Knit Gloves

Item	Size	Construction	Color	Quantity	Skid Quantity
GSLW-MN-2C-NRB	Men's	7 Gauge Blended String Knit	Natural	1 DZ bg/ 40 DZ/cs	12
GSLW-WN-2C-NRB	Women's				

- Cotton Polyester Blend
- 7 Gauge Blended String Knit
- Mens & Women Size Only



## GSMW-SZ-2P-NRB/Premium Medium Weight String Knit Gloves

Item	Size	Construction	Color	Quantity	Skid Quantity
GSMW-MN-2P-NRB	Men's	7 Gauge Blended String Knit	Natural	1 DZ pr bg/ 25 DZ/cs	16
GSMW-WN-2P-NRB	Women's				

- Cotton Polyester Blend
- 7 Gauge Blended String Knit
- Mens & Women Size Only



## GSMW-XS-2C/Medium Weight String Knit Gloves

Item	Size	Construction	Color	Quantity	Skid Quantity
GSMW-XS-2C	Extra Small	7 Gauge Blended String Knit	Natural	1 DZ/bg/ 25dz/cs	16

- Cotton Polyester Blend
- 7 Gauge Blended String Knit
- Extra Small Size Only

# STRING KNIT GLOVES

## GSMW-SZ-2C-NRB/Medium Weight String Knit Gloves



Item	Size	Construction	Color	Quantity	Skid Quantity
GSMW-MN-2C-NRB	Men's	7 Gauge Blended String Knit	Natural	1 DZ bg/ 25 DZ/cs	16
GSMW-WN-2C-NRB	Women's				

- Cotton Polyester Blend
- 7 Gauge Blended String Knit
- Mens & Women's Size Only

## GSMW-SZ-2C-NRB-BW70/Medium Weight String Knit Gloves



Item	Size	Construction	Color	Quantity	Skid Quantity
GSMW-MN-2C-BW70	Men's	7 Gauge Blended String Knit	Bright White	1 DZ/bg/ 25 DZ/cs	12
GSMW-WN-2C-BW70	Women's				

- Cotton Polyester Blend
- 7 Gauge Blended String Knit
- Mens & Women's Size Only

## GSHW-SZ-1C-NRB/Heavy Weight String Knit Gloves



Item	Size	Construction	Color	Quantity	Skid Quantity
GSHW-MN-1C-NRB	Men's	7 Gauge Blended String Knit	Natural	1 DZ/bg/ 25 DZ/cs	16
GSHW-WN-1C-NRB	Women's				

- Cotton Polyester Blend
- 7 Gauge Blended String Knit
- Mens & Women's Size Only

## GSMW-SZ-2C-GY/Gray Medium Weight String Knit Gloves



Item	Size	Construction	Color	Quantity	Skid Quantity
GSMW-MN-2C-GY	Men's	7 Gauge Blended String Knit	Gray	1 DZ/bg/ 30 DZ/cs	16
GSMW-WN-2C-GY	Women's				

- Cotton Polyester Blend
- 7 Gauge Blended String Knit
- Mens & Women's Size Only



# PERSONAL PROTECTIVE EQUIPMENT



# SHOE & BOOT COVERS

SAFETY  
ZONE™

Item	Description	Color	Size	Quantity	Skid Quantity
M1070	Promax® Shoe Cover Elastic Ankle	White	16" Length	400/cs	48
M2004B-CPE	Embossed CPE Shoe Cover	Blue	Large/Extra Large	300/cs	48
M2004B-CPE-XL	Embossed CPE Shoe Cover	Blue	15" Length Extra Large	100/bg 300/cs	48
M2004B-CPE-2X	Embossed CPE Shoe Cover	Blue	16" Length 2X Large	100/bg 300/cs	48
M2004W-CPE	Embossed CPE Shoe Cover	White	Large/Extra Large	300/cs	48
M2004W-CPE-L	Embossed CPE Shoe Cover	White	14" Length Large	300/cs	60
M2004W-CPE-XL	Embossed CPE Shoe Cover	White	15" Length Extra Large	300/cs	48

M2004W-CPE-(SIZE)



M2004B-CPE-(SIZE)

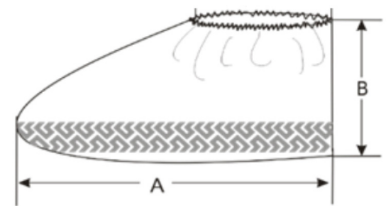

## SHOE COVER FIT GUIDE

SS Codes	Old SZ Codes	A	B	Description
M21BSZ-300	DSCL-300	16"	6.3"	PolyLite® Shoe Cover, Non-Skid Tread, 16" Length, Large, Blue, (3 Bags of 100) 300/CS
M21BSZ-300-XL	DSCL-300-XL	18"	6.3"	PolyLite® Shoe Cover with Non-Skid Tread, 18", Lt. Blue, 2X, (3 Bags of 100) 300/CS
M21BSZ-300-2X	DSCW-300-XL	18"	6.3"	PolyLite® Shoe Cover with Non-Skid Tread, 19", Lt. Blue, 2X, (3 Bags of 100) 300/CS
M21WSZ-300-XL	DSCL-300-2X	19"	7"	PolyLite® Shoe Cover with Non-Skid Tread, 18" Length, Large, White (3 Bags of 100) 300/CS
M2105B-N/S-16		16"	6.3"	PolyLite® Shoe Cover, Non-Skid Tread, 16" Length, Large, Blue, 300/CS
M2105B-N/S-18		16"	6.3"	PolyLite® Shoe Cover with Non-Skid Tread, 18", Lt. Blue, 2X, 300/CS
M2105W-N/S-16		18"	6.3"	PolyLite® Shoe Cover with Non-Skid Tread, 16" Length, Large, White 300/CS
M2105W-N/S-18		18"	6.3"	PolyLite® Shoe Cover, Non-Skid Tread, 18" Length, 2X, White, 300/CS

# SHOE & BOOT COVERS

Item	Description	Color	Size	Quantity	Skid Quantity
M21BSZ-300	PolyLite® Shoe Cover Non-Skid Tread	Blue	16" Length Large	100/bg 300/cs	60
M21BSZ-300-2X	PolyLite® Shoe Cover Non-Skid Tread	Blue	18" Length 2X-Large	100/bg 300/cs	48
M21WSZ-300-XL	PolyLite® Shoe Cover Non-Skid Tread	White	16" Length X-Large	100/bg 300/cs	60
M21BSZ-300-XL	Polypropylene Shoe Cover Non-Skid Tread w/Elastic	Blue	X-Large	100/bg 300/cs	60
M2105B-N/S-16	PolyLite® Shoe Cover Non-Skid Tread	Blue	16" Length Large	100/bg 300/cs	60
M2105B-N/S-18	PolyLite® Shoe Cover Non-Skid Tread	Blue	18" Length Large	100/bg 300/cs	60
M2105W-N/S-16	PolyLite® Shoe Cover Non-Skid Tread	White	16" Length Large	100/bg 300/cs	12
M2105W-N/S-18	PolyLite® Shoe Cover Non-Skid Tread	White	18" Length 2X-Large	100/bg 300/cs	48
M2115B-N/S-XL	Polypropylene Shoe Cover Non-Skid Tread w/Elastic	Blue	X-Large	100/bg 300/cs	80
M2115B-N/S-L-MM	Shoe Cover Non-Skid w/Elastic, Machine Made	Blue	Large	100/bg 300/cs	80
M2115B-N/S-XL-MM	Shoe Cover Non-Skid w/Elastic, Machine Made	Blue	X-Large	100/bg 300/cs	80
M2115B-N/S-2X-MM	Shoe Cover Non-Skid w/Elastic, Machine Made	Blue	2X-Large	100/bg 300/cs	80

M21BSZ-300-(SIZE)



M21WSZ-300-XL





Item	Description	Color	Size	Quantity	Skid Quantity
M2140-XL	SMS Polypropylene Shoe Cover	White	X-Large	200/cs	72
M2222B-L-16	PE Coated Super Sticky Shoe Cover	Blue	16" Length	300/cs	80
M2222B-XL-18	PE Coated Super Sticky Shoe Cover	Blue	18" Length	300/cs	72
M901-N/S-GREY	Microporous Shoe Cover, Elastic Ankles, Non-Skid	Grey	X-Large	400/cs	12
M901-N/S-2X	Microporous Shoe Cover, Elastic Ankles, Non-Skid	Grey	2X-Large	400/cs	12
MCPB-3-E/T-2X-125	3 Mil Polyethylene Boot Cover w/Elastic Top	Clear	2X-Large	250/cs	80
MCPB-4-2X-125	4 Mil Polyethylene Boot Cover w/Tie Top	Clear	2X-Large	250/cs	80
MCPB-6-2X-125	6 Mil Polyethylene Boot Cover w/Tie Top	Clear	2X-Large	250/cs	48
MCPB-3-XL-250	3 Mil Polyethylene Boot Cover	Clear	X-Large	500/cs	48
MCPB-6-XL-250	6 Mil Polyethylene Boot Cover w/Tie Top	Clear	2X-Large	500/cs	48
MCPB-6-E/T-XL-250	6 Mil Polyethylene Boot Cover w/Elastic Top	Clear	X-Large	500/cs	48
MCPB-6-E/T-2X-250	6 Mil Polyethylene Boot Cover w/Elastic Top	Clear	2X-Large	500/cs	12
MCPE-12W	CPE Sticky Shoe Cover	White	12" Length	300/cs	48
MCPE-16W/SCR-U	CPE Sticky Shoe Cover	White	16" Length/ Universal Size	300/cs	48

MCPB-3-XL-250



MCPB-6-XL-250



MCPB-6-E/T-XL-250



# SHOE & BOOT COVERS

Item	Description	Color	Size	Quantity	Skid Quantity
BN70-MD	Heavyweight Nuke Boot, Grit Sole	Yellow	Medium	50/cs	36
BN70-LG	Heavyweight Nuke Boot, Grit Sole	Yellow	Large	50/cs	36
BN70-XL	Heavyweight Nuke Boot, Grit Sole	Yellow	X-Large	50/cs	36
BN70-2XL	Heavyweight Nuke Boot, Grit Sole	Yellow	2X-Large	50/cs	36
BN70-3XL	Heavyweight Nuke Boot, Grit Sole	Clear	3X-Large	50/cs	48

BN70



#### SHOE COVER FIT GUIDE

LARGE - Fits Shoe Sizes 7-10, Fits Boot Sizes 7-9  
 XLARGE - Fits Shoe Sizes 9-14, Fits Boot Sizes 10-13  
 2X LARGE - Fits Shoe Sizes 15-18, Fits Boot Sizes 14-18

## White Sleeves

Item	Description	Size	Quantity	Skid Quantity
M1040	Breathable Microporous Sleeve	18" Length	200/cs	55
M1040-KC	Promax® Sleeve Cover w/Knit Cuff	18" Length	200/cs	44
M2400	PolyLite® Sleeve Cover	18" Length	200/cs	48
M2410	ProLite® Sleeve Cover	18" Length	200/cs	48
M2422	PolyLite® Sleeve Cover	22" Length	200/cs	48
MPE-165-FP-HM	Polyethylene Sleeve, Flat Pack	16" Length	2000/cs	48
MPE-165-RP-HM	Polyethylene Sleeve, Roll Pack	16" Length	2000/cs	48
MPE-185-1000W	Polyethylene Sleeve, Roll Pack	18" Length	1000/cs	48
MPE-185-FP-HM	Polyethylene Sleeve, Flat Pack	18" Length	2000/cs	48
MPE-185-RP-HM	Polyethylene Sleeve, Roll Pack	18" Length	2000/cs	48
MVW-6HS	6 Mil Vinyl Sleeve Cover	18" Length	12 DZ pr/cs	48
MVW-6HS-4SZ	4 Mil Vinyl Sleeve Cover	18" Length	6 DZ pr/cs	77

## Blue Sleeves

Item	Description	Size	Quantity	Skid Quantity
MMVA-4HS	4 Mil Vinyl Alternative Sleeve	18" Length	150/cs	48
MMVA-4HS-EW	4 Mil Vinyl Extra Wide Alternative Sleeve	18" Length	150/cs	50
MMVA-6HS	6 Mil Vinyl Alternative Sleeve	18" Length	150/cs	48
MPE-165-FP-B-HM	Polyethylene Sleeve, Flat Pack	16" Length	2000/cs	48
MPE-165-FP-B-MM	Polyethylene Sleeve, Flat Pack	16" Length	2000/cs	48
MPE-165-RP-B-HM	Polyethylene Sleeve, Roll Pack	16" Length	2000/cs	48
MPE-185-1000B	Polyethylene Sleeve, Roll Pack	18" Length	1000/cs	44
MPE-185-FP-B-HM	Polyethylene Sleeve, Flat Pack	18" Length	2000/cs	48
MPE-185-RP-B-HM	Polyethylene Sleeve, Roll Pack	18" Length	2000/cs	48
MVB-6HS-4	4 Mil Vinyl Sleeve Cover	18" Length	12 DZ pr/cs	48
MVB-6HS	6 Mil Vinyl Sleeve Cover	18" Length	12 DZ pr/cs	48
MVB-8HS	8 Mil Vinyl Sleeve Cover	18" Length	12 DZ pr/cs	48
MVB-6HS-4SZ	4 Mil Vinyl Sleeve Cover	18" Length	6 DZ pr/cs	48

## Yellow & Clear Sleeves

Item	Description	Size	Quantity	Skid Quantity
MMVA-6HS-Y	6 Mil Vinyl Alternative Sleeve	18" Length	150/cs	48
MPE-185-1000C	Polyethylene Sleeve, Roll Pack	18" Length	1000/cs	55
MVC-6HS	6 Mil Vinyl Sleeve Cover	18" Length	12 DZ pr/cs	48
MYU-18	Urethane Sleeve, Elastic Ends	18" Length	8 DZ pr/cs	18

# SLEEVES



MPE-185-1000W



M2410



MVB-6HS-4SZ



MPE-185-1000C



MVW-6HS-4SZ

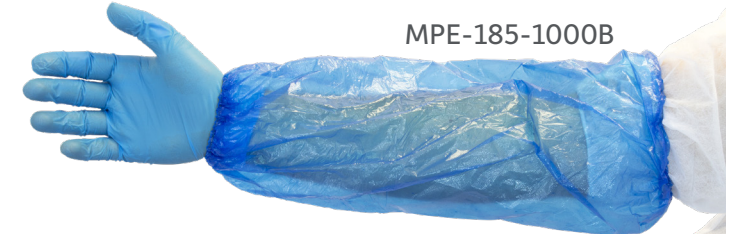

MPE-185-1000B



M2400



M1040

# HOODS, BEARD COVERS AND HAIRNETS



M2302WSZ



M2302BSZ

## Hood & Beard Covers

Item	Description	Size	Quantity	Skid Quantity
M1050	Promax® Microporous Hood & Elastic Face Cover	One Size	100/CS	32
M2302B	Blue Hood & Beard Cover	One Size	100 bg/10 cs	32
M2302R	Red Hood & Beard Cover	One Size		
M2302W	White Hood & Beard Cover	One Size		
M2302-3X	White Hood & Beard Cover	3X		
M2302-XLONG	White Hood & Beard Cover	X-Long		
M2302WSZ	White Hood & Beard Cover	One Size		
M2320BSZ	Blue Hood & Beard Cover	One Size		
M2302WXLSZ	White Hood & Beard Cover	X-Large		

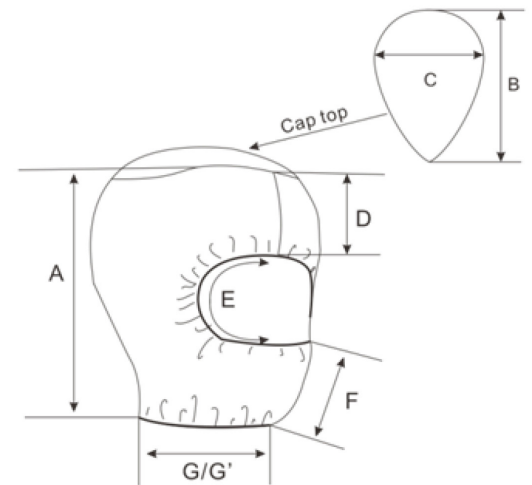

### HOOD DIMENSIONS

Item#	A	B	C	D	E	F	G/G'
M2302WSZ M2302BSZ	36 +/- 2 CM	24 +/- 1 CM	16 +/- 1 CM	6 +/- 1 CM	Relax: 18 +/- 1 CM	13 +/- 1 CM	G-Relax: 18 +/- 1 CM G'-Stretched: 40 +/- 2 CM
M2302WXLSZ	37 +/- 2 CM	25.5 +/- 1 CM	18 +/- 1 CM	6 +/- 1 CM	Relax: 18 +/- 1 CM	13 +/- 1 CM	G-Relax: 18 +/- 1 CM G'-Stretched: 41 +/- 2 CM
M2302B M2302R M2302W	42 +/- 2 CM	26 +/- 1 CM	16 +/- 1 CM	7 +/- 1 CM	Relax: 16 +/- 1 CM	16 +/- 1 CM	G-Relax: 16 +/- 1 CM G'-Stretched: 35 +/- 2 CM
M2302W-X-LONG	46 +/- 2 CM	28 +/- 1 CM	18 +/- 1 CM	7 +/- 1 CM	Relax: 16 +/- 1 CM	19 +/- 1 CM	G-Relax: 16 +/- 1 CM G'-Stretched: 37 +/- 2 CM
M2302W-3X	48 +/- 2 CM	31 +/- 1 CM	21 +/- 1 CM	7 +/- 1 CM	Relax: 16 +/- 1 CM	21 +/- 1 CM	G-Relax: 16 +/- 1 CM G'-Stretched: 42 +/- 2 CM

# HAIR NETS

## Brown Hairnets

Item	Description	Size	Quantity	Skid Quantity
MC-18-1000/BR	Heavyweight Polyester Hairnet	18"	100/bg 10/cs	48
MC-21-1000/BR	Heavyweight Polyester Hairnet	21"	100/bg 10/cs	32
MC-24-1000/BR	Heavyweight Polyester Hairnet	24"	100/bg 10/cs	48
MC-28-1000/BR	Heavyweight Polyester Hairnet	27"	100/bg 10/cs	120
MN-22-1440/BR	Lightweight Nylon Hairnet	22"	144/bx 10 cs	120
MN-28-1440/BR	Lightweight Nylon Hairnet	28"	144/bx 10 cs	100



MC-(SIZE)-1000/W

## White Hairnets

Item	Description	Size	Quantity	Skid Quantity
MC-18-1000/W	Heavyweight Polyester Hairnet	18"	100/bg 10/cs	48
MC-21-1000/W	Heavyweight Polyester Hairnet	21"	100/bg 10/cs	48
MC-24-1000/W	Heavyweight Polyester Hairnet	24"	100/bg 10/cs	48
MC-28-1000/W	Heavyweight Nylon Mesh Hairnet	27"	100/bg 10/cs	120
MC-30-1000/W	Heavyweight Nylon Hairnet	30"	100/bg 10/cs	82
MN-22-1440/W	Nylon Hairnet	22"	144/bx 10 cs	84
MN-22-1440/W	Nylon Hairnet	22"	144/bx 10 cs	84



MN-(SIZE)-1440/BR

## Blue Hairnets

Item	Description	Size	Quantity	Skid Quantity
MC-21-1000/B	Nylon Mesh Hairnet	21"	100/bg 10/cs	48
MC-24-1000/B	Nylon Mesh Hairnet	24"	100/bg 10/cs	48
MC-28-1000/B	Nylon Mesh Hairnet	28"	100/bg 10/cs	120
MC-30-1000/B	Nylon Mesh Hairnet	30"	100/bg 10/cs	100



MN-(SIZE)-1440/W

## Black Hairnets

Item	Description	Size	Quantity	Skid Quantity
MC-21-1000/BLK	Nylon Mesh Hairnet	21"	100/bg 10/cs	32
MC-24-1000/BLK	Nylon Mesh Hairnet	24"	100/bg 10/cs	48
MC-28-1000/BLK	Nylon Mesh Hairnet	28"	100/bg 10/cs	100
MN-22-1440/BLK	Heavyweight Nylon Hairnet	22"	144/bx 10 cs	120



MN-(SIZE)-1440/BLK

## Light Brown Hairnets

Item	Description	Size	Quantity	Skid Quantity
MN-22-1440/LBR	Lightweight Nylon Hairnet	22"	144/bx 10 cs	120
MN-28-1440/LBR	Lightweight Nylon Hairnet	28"	144/bx 10 cs	100

## Blue Bouffants

Item	Description	Size	Quantity	Skid Quantity
MB-19-1000/B	Polypropylene Bouffant Cap	19"	100/bg 10/cs	48
MB-21-1000/B	Bouffant Cap	21"	100/bg 10/cs	48
MB-24-1000/B	Bouffant Cap	24"	100/bg 10/cs	48
MB-24-1000/NB	Bouffant Cap	24"	100/bg 10/cs	48
MB-28-1000/B	Bouffant Cap	28"	100/bg 10/cs	48
MB-21-B-PLEATED	Pleated Bouffant Cap	21"	100/bg 10/cs	48
MB-24-B-PLEATED	Pleated Polypropylene Bouffant Cap	24"	100/bg 10/cs	40

## White Bouffants

Item	Description	Size	Quantity	Skid Quantity
MB-19-1000/W	Bouffant Cap	19"	100/bg 10/cs	48
MB-21-1000/W	Bouffant Cap	21"	100/bg 10/cs	48
MB-24-1000/W	Bouffant Cap	24"	100/bg 10/cs	48
MB-28-1000/W	Bouffant Cap	28"	100/bg 10/cs	48
MB-19-PLEATED/W	Pleated Polypropylene Bouffant Cap	19"	100/bg 10/cs	48
MB-21-PLEATED/W	Pleated Polypropylene Bouffant Cap	21"	100/bg 10/cs	40
MB-24-PLEATED/W	Pleated Bouffant Cap	24"	100/bg 10/cs	80

## Green Bouffants

Item	Description	Size	Quantity	Skid Quantity
MB-19-1000/G	Polypropylene Bouffant Cap	19"	100/bg 10/cs	48
MB-21-1000/G	Polypropylene Bouffant Cap	21"	100/bg 10/cs	48
MB-24-1000/G	Polypropylene Bouffant Cap	24"	100/bg 10/cs	48

## Orange Bouffants

Item	Description	Size	Quantity	Skid Quantity
MB-21-1000/OR	Polypropylene Bouffant Cap	21"	100/bg 10/cs	48
MB-24-1000/O	Polypropylene Bouffant Cap	24"	100/bg 10/cs	48

## Red Bouffants

Item	Description	Size	Quantity	Skid Quantity
MB-21-1000/R	Polypropylene Bouffant Cap	21"	100/bg 10/cs	48
MB-24-1000/R	Polypropylene Bouffant Cap	24"	100/bg 10/cs	48

## Yellow Bouffants

Item	Description	Size	Quantity	Skid Quantity
MB-21-1000/Y	Polypropylene Bouffant Cap	21"	100/bg 10/cs	24
MB-24-1000/Y	Polypropylene Bouffant Cap	24"	100/bg 10/cs	48

# BOUFFANTS

ALL SAFETY ZONE POLYPROPYLENE BOUFFANT CAPS AND BEARD NETS ARE LATEX FREE

MB-(SIZE)-1000/W



MB-(SIZE)-PLEATED-W



MB-(SIZE)-B-PLEATED



MB-(SIZE)-1000-Y



MB-(SIZE)-1000-G



MB-(SIZE)-1000/B



MB-(SIZE)-1000/O



MB-(SIZE)-1000/R





# BEARD COVERS & BEARD NETS



## Blue Beard Covers

Item	Description	Size	Quantity	Skid Quantity
MCBC-1000/B	Nylon Mesh Beard Cover	One Size	1000/cs	84
MBC-1000/B	Polypropylene Beard Cover	24"	100/bg 10/cs	48

## White Beard Covers

Item	Description	Size	Quantity	Skid Quantity
MCBC-1000/W	Polyester Mesh Beard Cover	24"	100/bg 10/cs	80
MBC-1000/W	Polypropylene Beard Cover	28"	100/bg 10/cs	48
MBC-1000-21	Polypropylene Beard Cover	21"	100/bg 10/cs	48
MBC-PLEATED/W	Spunbond Polypropylene Pleated, Machine Made	19"	100/bg 10/cs	80

## Brown Beard Covers

Item	Description	Size	Quantity	Skid Quantity
MCBC-1000/BR	Polyester Mesh Beard Cover	One Size	100/bg 10/cs	80

## Green Beard Covers

Item	Description	Size	Quantity	Skid Quantity
MBC-1000/G	Polypropylene Beard Cover	21"	100/bg 10/cs	48

MBC-1000/W

MBC-1000/B

MCBC-1000/W

MCBC-1000/BR



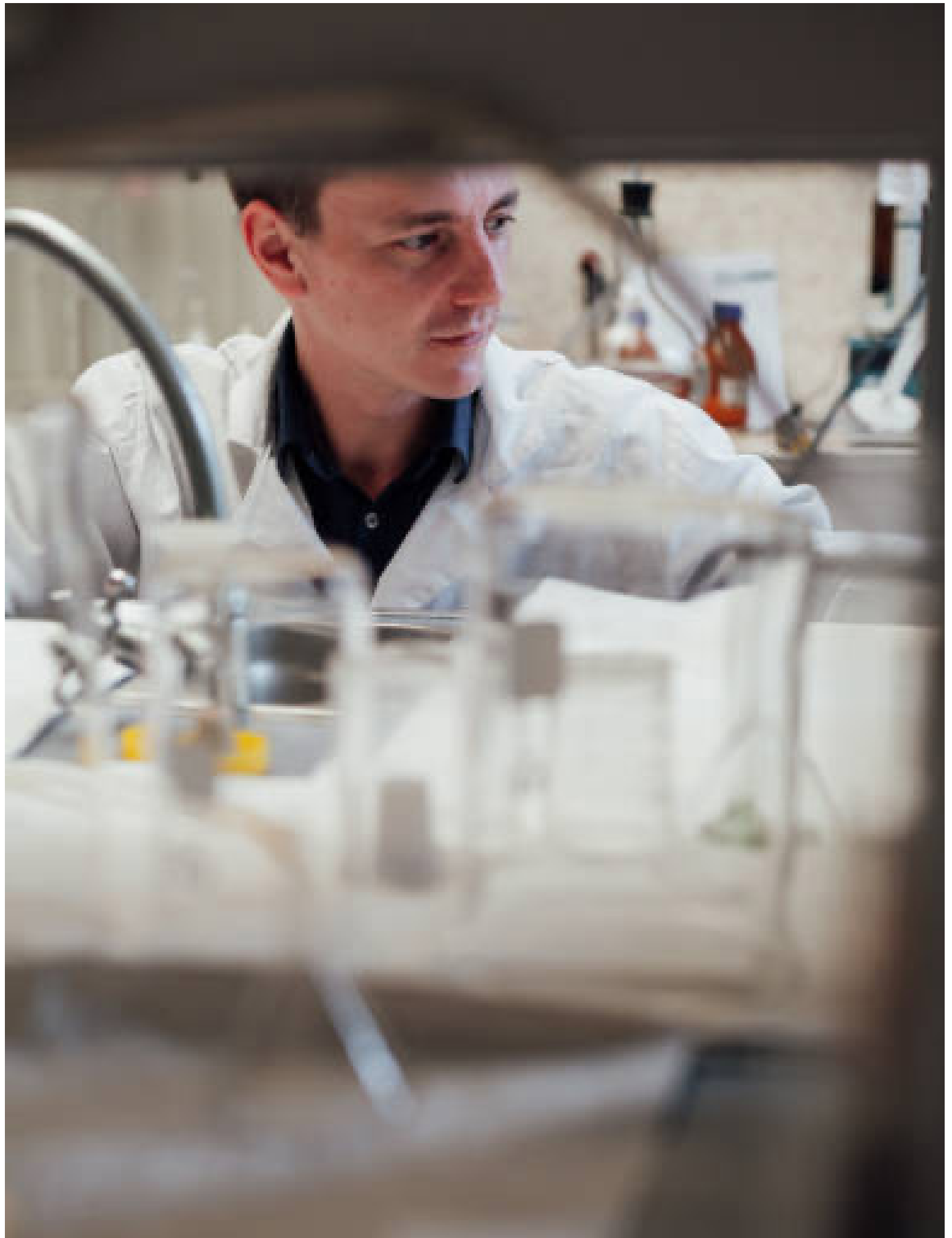



## White PolyLite® Lab Coats

Item	Description	Size	Quantity	Skid Quantity
M1710-(SIZE)	Snap Front, No Pockets, Long Sleeve, Open Wrists	SM-7X	30/cs	48
M1710-E/W-(SIZE)	Snap Front, No Pockets, Long Sleeve, Elastic Wrists	SM-5X	30/cs	48
M1714-(SIZE)-E/W	Polypropylene Lab Coat, Elastic Wrists	SM-5X	30/cs	48
M1730-(SIZE)	Snap Front, 3 Pockets, Long Sleeve, Open Wrists	SM-5X	30/cs	48
M1734-(SIZE)-E/W	Polypropylene Lab Coat, Pockets, Elastic Wrists	SM-5X	30/cs	48

## Blue PolyLite® Lab Coats

Item	Description	Size	Quantity	Skid Quantity
M1710B-(SIZE)	Snap Front, No Pockets, Long Sleeve, Open Wrists	SM-7X	30/cs	48
M1710B-E/W-(SIZE)	Snap Front, No Pockets, Long Sleeve, Elastic Wrists	SM-5X	30/cs	48
M1714B-(SIZE)-E/W	Polypropylene Lab Coat, Elastic Wrists	SM-4X	30/cs	48
M1734B-(SIZE)-E/W	Polypropylene Lab Coat, Pockets, Elastic Wrists	SM-4X	30/cs	48

## Green PolyLite® Lab Coats

Item	Description	Size	Quantity	Skid Quantity
M1710G-(SIZE)	Snap Front, No Pockets, Long Sleeve, Open Wrists	SM-4X	30/cs	48

## Red PolyLite® Lab Coats

Item	Description	Size	Quantity	Skid Quantity
M1710R-E/W-XL	Snap Front, No Pockets, Long Sleeve, Elastic Wrists	SM-5X	30/cs	48

## Promax® II SMS Diagram

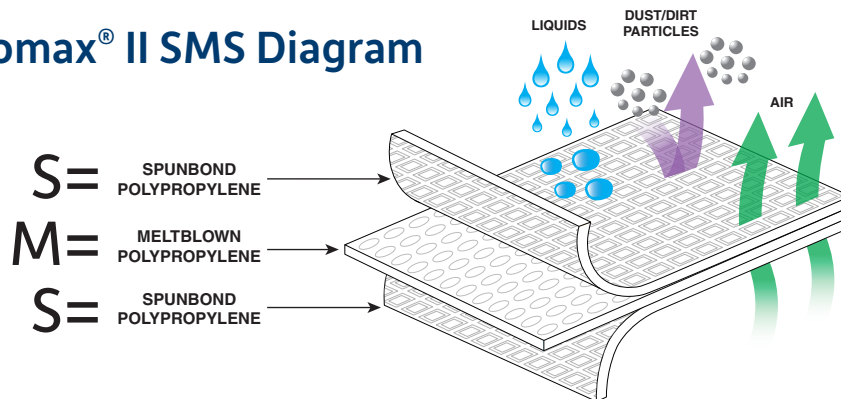

# LAB COATS

## White Promax II® Lab Coats

Item	Description	Size	Quantity	Skid Quantity
M1740-(SIZE)	Snap Front, 3 Pockets, Long Sleeve, Knit Wrists and Collar	SM-4X	30/cs	36

## Light Blue Promax II® Lab Coats

Item	Description	Size	Quantity	Skid Quantity
M1740B-(SIZE)	Snap Front, 3 Pockets, Long Sleeve, Knit Wrists and Collar	SM-3X	30/cs	36

## White Promax® Lab Coats

Item	Description	Size	Quantity	Skid Quantity
M1010-(SIZE)	Snap Front, No Pockets, Long Sleeve, Open Wrists	SM-6X	30/cs	36
M1010-E/W(SIZE)	Snap Front, No Pockets, Long Sleeve, Elastic Wrists	SM-6X	30/cs	36
M1020-(SIZE)	Snap Front, 3 Pockets, Long Sleeve, Open Wrists	SM-5X	30/cs	36
M1020-E/W(SIZE)	Snap Front, 3 Pockets, Long Sleeve, Elastic Wrists	SM-5X	30/cs	36

M1710-E/W-(SIZE)



M1734-(SIZE)-E/W



M1734B-(SIZE)-E/W



M1740B-(SIZE)



M1020-E/W-(SIZE)



**White PolyLite® Coveralls**

Item	Description	Size	Quantity	Skid Quantity
M1100-(SIZE)	Zip Front, Open Wrists & Ankles	SM-5X	25/cs	48
M1200-(SIZE)	Zip Front, Elastic Wrists & Ankles	SM-6X	25/cs	48
M1500-(SIZE)	Zip Front, Elastic Wrists, Attached Hood and Boots	SM-6X	25/cs	48

**Navy Blue PolyLite® Coveralls**

Item	Description	Size	Quantity	Skid Quantity
M1100B-(SIZE)	Zip Front, Open Wrists & Ankles	SM-7X	25/cs	48
M1200B-(SIZE)	Zip Front, Elastic Wrists & Ankles	SM-6X	25/cs	48
M1500B-(SIZE)	Zip Front, Elastic Wrists, Attached Hood and Boots	SM-6X	25/cs	48

**White 40G Polypro Coveralls**

Item	Description	Size	Quantity	Skid Quantity
M1220-(SIZE)	40G Polypro, Elastic Wrists & Ankles	SM-6X	25/cs	48
M1520-(SIZE)	40G Polypro, Elastic Wrists & Ankles, Attached Hood and Boots	SM-5X	25/cs	48

**White Promax® Coveralls**

Item	Description	Size	Quantity	Skid Quantity
M1012-(SIZE)	Zip Front, Open Wrists & Ankles	SM-6X	25/cs	48
M1014-(SIZE)	Zip Front, Elastic Wrists, Attached Hood and Boots	SM-6X	25/cs	48
M1017-(SIZE)	Zip Front, Elastic Wrists & Ankles	SM-6X	25/cs	48
M1028-(SIZE)	Zip Front, Elastic Wrists & Ankles, Attached Hood	SM-6X	25/cs	48

**White Promax II® Coveralls**

Item	Description	Size	Quantity	Skid Quantity
M1140-(SIZE)	Zip Front, Open Wrists & Ankles	SM-5X	25/cs	48
M1240-(SIZE)	Zip Front, Elastic Wrists & Ankles	SM-5X	25/cs	48
M1440-(SIZE)	Zip Front, Attached Hood, Elastic Wrists & Ankles	SM-4X	25/cs	48
M1540-(SIZE)	Zip Front, Attached Hood & Boot, Elastic Wrists & Ankles	SM-5X	25/cs	48

# COVERALLS

## Light Blue Promax II® Coveralls

Item	Description	Size	Quantity	Skid Quantity
M1140B-(SIZE)	Zip Front, Open Wrists & Ankles	SM-5X	25/cs	36/48
M1142B-(SIZE)	Zip Front, Open Wrists & Ankles, 2 Pockets, Elastic Back	SM-5X	25/cs	36
M1240B-(SIZE)	Zip Front, Elastic Wrists & Ankles	SM-6X	25/cs	36
M1440B-(SIZE)	Zip Front, Attached Hood, Elastic Wrists & Ankles	SM-5X	25/cs	36
M1540B-(SIZE)	Zip Front, Attached Hood & Boot, Elastic Wrists & Ankles	SM-5X	25/cs	36

## ProChem® Yellow Coveralls

Item	Description	Size	Quantity	Skid Quantity
MPC5428-(SIZE)	Zip Front, Serge Seam, Attached Hood, Elastic Wrists & Ankles	LG-5X	25/cs	48
MCP5414-(SIZE)	Zip Front, Serge Seam, Attached Hood & Boots, Elastic Wrists	LG-3X	25/cs	48

## PyroMax® Fire Resistant Blue Coveralls

Item	Description	Size	Quantity	Skid Quantity
MP7412B-(SIZE)	Zip Front, Open Wrists & Ankles	LG-5X	25/cs	48
MP7428B4-(SIZE)	Zip Front, Attached Hood, Elastic Wrists & Ankles	MD-5X	25/cs	48

M1100-(SIZE)



M1220-(SIZE)



M1014-(SIZE)



M1240-M



M1100B-(SIZE)



**Yellow PolyLite® Isolation Gowns**

Item	Description	Size	Quantity	Skid Quantity
M2900-XL	Long Sleeve, Elastic Wrists	XL	10/pack 5/cs	144
M2900-2X	Long Sleeve, Elastic Wrists	2X	10/pack 5/cs	144

**Blue PolyLite® Isolation Gowns**

Item	Description	Size	Quantity	Skid Quantity
M2900B	Long Sleeve, Elastic Wrists	LG	10/pack 5/cs	144

**White CPE Gowns**

Item	Description	Size	Quantity	Skid Quantity
MCPE-45W	1.75 Mil, Long Sleeve w/Thumb Loop	45"	100 /cs	28
MCPE-45B-EW	1.75 Mil, Long Sleeve w/Elastic Wrists, Embossed	45"	100/cs	28
MCPE-50W-E/W	1.75 Mil, Long Sleeve w/Elastic Wrists	50"	100 /cs	28
MCPE-60W	1.75 Mil, Long Sleeve w/Elastic Wrists	60"	100/cs	28

**Blue CPE Gowns**

Item	Description	Size	Quantity	Skid Quantity
MCPE-45B	1.75 Mil, Long Sleeve w/Thumb Loop	45"	100/cs	28
MCPE-50B	1.75 Mil, Long Sleeve w/Thumb Loop	50"	100/cs	28
MCPE-55B	1.75 Mil, Long Sleeve w/Thumb Loop	55"	100/cs	28
MCPE-45B-E/W	1.75 Mil, Long Sleeve w/Elastic Wrists, Embossed	45"	100/cs	28
MCPE-60B	1.75 Mil, Long Sleeve w/Elastic Wrists	60"	100/cs	28
MCPE-45B-L-4	4 Mil, Long Sleeve w/Thumb Loop	45"	100/cs	28
MCPE-50B-XL-4	4 Mil, Long Sleeve w/Thumb Loop	50"	100/cs	28

**Purple CPE Gowns**

Item	Description	Size	Quantity	Skid Quantity
MCPE-60P	1.75 Mil, Long Sleeve w/Elastic Wrists	60"	100/cs	28

# ISOLATION GOWNS

## Blue Vinyl Alternative Gowns

Item	Description	Size	Quantity	Skid Quantity
MMVA-4G-B-L	4 Mil, Long Sleeve w/Thumb Loops	42"x50" LG	50/cs	70
MMVA-4G-B-XL	4 Mil, Long Sleeve w/Thumb Loops	42"x50" XL	50/cs	70
MMVA-4G-B-XL-EW-S	4 Mil, Long Sleeve w/Elastic Wrists/Neck	45"x55" XL	50/cs	70
MMVA-6G-B-L	6 Mil, Long Sleeve w/Thumb Loops	42"x50" LG	50/cs	70
MMVA-6G-B-XL	6 Mil, Long Sleeve w/Thumb Loops	42"x50" XG	50/cs	70

## White Promax® Pants

Item	Description	Size	Quantity	Skid Quantity
M1095-XL	Promax® Pants, Elastic Waist	XL	50/cs	70
M1095-2L	Promax® Pants, Elastic Waist	2X	50/cs	70
M1095-3X	Promax® Pants, Elastic Waist	3X	50/cs	70

DGIH-XL-Y



M1095-XL



M2900-XL



MCPE-50B



MCPE-60-W



MCPE-45W



MMVA-4G-B-XL





## White ProMax®/PolyLite®/Prolite Aprons

Item	Description	Size	Quantity	Skid Quantity
M1060	ProMax® Apron, Sewn Ties	28"x36"	100/cs	70
M2500	PolyLite® Apron, Sewn Ties	28"x36"	100/cs	144
M2510	PolyLite® PE Coated PolyPro Apron, Sewn Ties	28"x36"	100/cs	108
MWS-2700-3X-W-100	PolyLite® Wrap Smock	3X	100/cs	56

## White Vinyl & Urethane Aprons

Item	Description	Size	Quantity	Skid Quantity
ME6W-45	6 Mil Die Cut Vinyl Apron	35"X45"	6 DZ/cs	50
ME6W-50	6 Mil Die Cut Vinyl Apron	35"X50"	6 DZ/cs	50
ME8W-48	8 Mil Die Cut Vinyl Apron	35"X48"	6 DZ/cs	50
MHW-45	6 Mil Vinyl Apron Hemmed, w/ String Ties	35"X45"	6 DZ/cs	50
MHW-48	6 Mil Vinyl Apron Hemmed w/ String Ties	35"X48"	6 DZ/cs	50
MUW-55	6 Mil Vinyl Apron Unhemmed String Ties	35"X55"	6 DZ/cs	50
ME8W-45SZ	8 Mil Die Cut Vinyl Apron	35"X45"	6 DZ/cs	44
MUW-45SZ	6 Mil 35"X45" Raw Edge Vinyl Apron, String Ties	35"X45"	6 DZ/cs	

## Clear, Yellow and Green Vinyl & Urethane Aprons

Item	Description	Size	Quantity	Skid Quantity
M844	8 Mil Vinyl Apron, Clear	36"X44"	6 DZ/cs	50
MYU-48	Urethane Apron, String Ties, Yellow	35"X48"	4 DZ/cs	50
MYU-55	Urethane Apron, String Ties, Yellow	35"X45"	4 DZ/cs	50
MG-20-50SZ	20 MM Green PVC Apron, Stomach Patch, Sold Individually	36"X50"	96/cs	24
MY-35-50SZ	35 MM Yellow Viny Reinforced, Polyester Apron, Sold Individually	35"X50"	50/cs	28

## Promax® Microporous Breathable Barrier Diagram

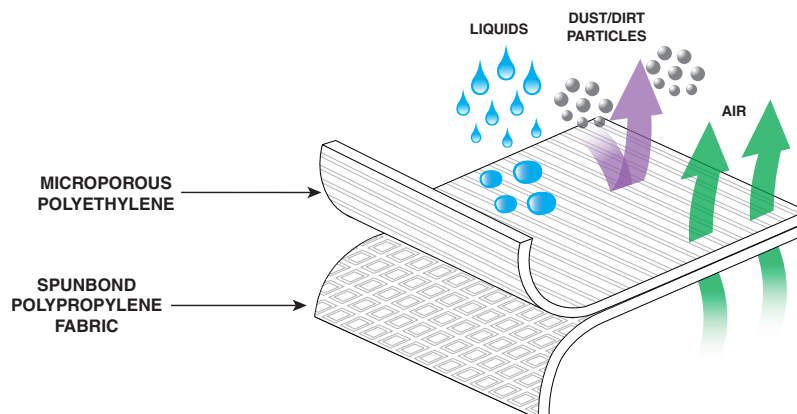

# APRONS

## Blue Vinyl & Urethane Aprons

Item	Description	Size	Quantity	Skid Quantity
ME6B-45	6 Mil Die Cut Vinyl Apron	35"X45"	6 DZ/cs	50
ME6B-48	6 Mil Die Cut Vinyl Apron	35"X48"	6 DZ/cs	50
ME6B-50	6 Mil Die Cut Vinyl Apron	35"X50"	6 DZ/cs	50
ME6B-55	6 Mil Die Cut Vinyl Apron	35"X55"	6 DZ/cs	50
MHB-45	6 Mil Vinyl Apron Hemmed w/String Ties	35"X45"	6 DZ/cs	50
MHB-48	6 Mil Vinyl Apron Hemmed w/String Ties	35"X48"	6 DZ/cs	84
MHB-55	6 Mil Vinyl Apron Hemmed w/String Ties	35"X55"	6 DZ/cs	50
MPB-48	8 Mil Vinyl Apron Hemmed, String Ties	35"X48"	6 DZ/cs	50
MPB-55	8 Mil Vinyl Apron Hemmed, String Ties	35"X55"	6 DZ/cs	50
MUB-45	6 Mil Vinyl Apron Unhemmed, String Ties	35"X45"	6 DZ/cs	50
MUB-45-4	4 Mil Vinyl Apron Unhemmed, String Ties	35"X45"	6 DZ/cs	50
MUB-48	6 Mil Vinyl Apron Unhemmed, String Ties	35"X48"	6 DZ/cs	50
MUB-50-4	4 Mil Vinyl Apron Unhemmed, String Ties	35"X50"	6 DZ/cs	50
MUB-55	6 Mil Vinyl Apron Unhemmed, String Ties	35"X55"	6 DZ/cs	50
MB-20-50	20 Mil PVC Apron	36"X50"	3 DZ/cs	50
MBU-48	Urethane Apron	35"X48"	4 DZ/cs	42
MBU-55	Urethane Apron	35"X55"	4 DZ/cs	50
ME6B-45-4SZ	4 Mil Die Cut Vinyl Apron	35"X45"	6 DZ/cs	
ME6B-45SZ	6 Mil Die Cut Vinyl Apron	35"X45"	6 DZ/cs	
MUB-45SZ	6 Mil Raw Edge Vinyl Apron, String Ties	35"X45"	6 DZ/cs	

ME6B-45-4SZ  
ME6B-45SZ



MUB-45SZ



MG-20-50SZ



MY-35-50SZ



## Blue Vinyl Alternative Aprons

Item	Description	Size	Quantity	Skid Quantity
MMVA-45-4	4 MIL Vinyl Alt. Apron w/Grommets	35"x45"	100/cs	70
MMVA-45-6	6 MIL Vinyl Alt. Apron w/Grommets	35"x45"	100/cs	70
MMVA-55-6	6 MIL Vinyl Alt. Apron w/Grommets	35"x55"	100/cs	70
MMVA-55-DC-4	4 MIL Vinyl Alt. Die Cut Apron	35"x55"	100/cs	70
MMVA-55-DC-6	6 MIL Vinyl Alt. Die Cut Apron	35"x55"	100/cs	70

## Yellow Vinyl Alternative Aprons

Item	Description	Size	Quantity	Skid Quantity
MMVA-45-6-Y	6 MIL Vinyl Alt. Apron w/Grommets	35"x45"	100/cs	70

## White Polyethylene Aprons

Item	Description	Size	Quantity	Skid Quantity
DAP10-28x46-WH	0 Micron Apron, HDPE	28"x46"	100/Header 10 Headers/cs	60
MDP-42W-I	1 Mil Apron, PE	24"x42"	100/bx-10bx/cs (Ind. packed)	66
MDP-46W-I	1 Mil Apron, PE	28"X46"	100/bx-10bx/cs (Ind. packed)	66
MDP-46W-S	1 Mil Apron, PE, Bulk Pack	28"X46"	100bg, 10bg/cs	66
MDP-46-W-BOXED	1 Mil Polyethylene Apron, Dispenser Box	28"X46"	100/bx 10bx/cs	55
MDP-46-2	2 Mil Apron, Dispenser Boxed	28"X46"	100/bx 5bx/cs	55
MDP-55W-1	1 Mil Polyethylene Apron	28"X55"	1000/cs	28

### Gilbert Says, Develop a Personal PPE Program

Your PPE program should outline hazards present and the proper PPE that is to be worn. The program should explain how to select and ensure the proper fit for PPE. The PPE program needs to cover proper inspection and maintenance of all PPE.

Source: [constructconnect.com](http://constructconnect.com)



## Blue Polyethylene Aprons

Item	Description	Size	Quantity	Skid Quantity
DAP10-28x46-BL	10 Micron Apron, HDPE	28"x46"	100/Header 10 Headers/cs	60
MDP-46B-S	1 Mil Apron, PE, Bulk Pack	28"X46"	100bg, 10bg/cs	55
MDP-46-B-2	2 Mil Apron, Dispenser Boxed	28"X46"	100/bx 5bx/cs	44

## Red & Yellow Polyethylene Aprons

Item	Description	Size	Quantity	Skid Quantity
DAP10-28x46-RD	10 Micron Red Apron, HDPE	28"x46"	100/Header 10 Headers/cs	60
DAP10-28x46-YE	10 Yellow Micron Apron, HDPE	28"x46"	100/Header 10 Headers/cs	60

MMVA-45-6-Y



MDP-46W-S



DAP10-28X46-BL



DAP10-28X46-RD



# EYE PROTECTION & ACCESSORIES



Item	Description	Quantity
ES-LCT	Pre Moistened Anti-Fog Lens Cleaning Towelettes	100/bx 10bx/cs
7348	Pro-Guard Lens Cleaning Station with 8oz Anti-static/Anit-fog solution and 600 tissues	6/cs
ES-21USACL	Red White & Blue Frame Eyewear, Clear with Adjustable Temple, ANSI Z87+	12 pr/bx
ES-32BKCL	Wrap Around Eyewear, Black Frame with Clear Lens, Articulating Adjustable Temple, ANSI Z87+	12 pr/bx
ES-32BLCL	Wrap Around Eyewear, Blue Frame with Clear Lens, Articulating Adjustable Temple, ANSI Z87+	12 pr/bx
ES-32BKSM	Wrap Around Eyewear, Black Frame with Smoke Lens, Articulating Adjustable Temple, ANSI Z87+	12 pr/bx
ES-32BKIO	Wrap Around Eyewear, Black or Blue Frame, Indoor/ Outdoor Lens with Articulating Adjustable Temple, ANSI Z87+	12pr/bx
ES-41BKCL	Wrap Around Eyewear, Black Frame, Clear, with Adjustable Temple, ANSI Z87+	12 pr/bx
ES-41BKSM	Wrap Around Eyewear, Black Frame, Smoke Lens with Adjustable Temple, ANSI Z87+	12 pr/bx
ES-41BKIO	Wrap Around Eyewear, Black Frame, Indoor/ Outdoor Lens with Adjustable Temple, ANSI Z87+	12 pr/bx
ES-51CLIO	Wrap Around Eyewear, Clear Frame, Indoor/ Outdoor Lens, ANSI Z87+	12 pr/bx
ES-51BKSM	Wrap Around Eyewear, Smoke Frame, Smoke Lens, ANSI Z87+	12 pr/bx
7334B	Pro-Guard® Classic 801 Safety Glasses, Clr Lens/ Blk Frame, ANSI	12 pr/bx; 12 bx/cs
7332	Pro-Guard® Classic 803 Safety Glasses. Clear Hard Coat Lens/Frame,ANSI	12 pr/bx; 12 bx/cs
7340	Pro-Guard® Classic 803 Safety Glasses, Clear Lens/Frame,ANSI	12 pr/bx; 12 bx/cs
7320	Pro-Guard® Classic 808 Series Chem Goggle, Indirect Vent, Anti-Fog	12 ea/bx; 5 bx/cs
7321	Pro-Guard® Classic 808 Series Chem Goggle, Ind Vent, Clr	12 ea/bx; 5 bx/cs
7322	Pro-Guard® Classic 808 Series, Perf. Chem. Impact Goggle w/Indir Vent, Clr	12 ea/bx; 5 bx/cs
8001CC	Pro-Guard® Classic 810 Safety Glasses, Clear Lens / Clear Frame	12 pr/bx; 12 bx/cs
8010	Pro-Guard® 820 Series Safety Glasses, wrap-around, meets ANSI	12 pr/bx; 12 bx/cs
8301000	Pro-Guard® 830 Series Safety Glasses, Clear Lens / Black Frame, ANSI	12 pr/bx; 12 bx/cs

ES-LCT



7348



8301000



# EYE PROTECTION & ACCESSORIES

ES-21BKCL



ES-21USACL



ES-32BKCL



ES-32BKIO



ES-32BKSM



ES-41BKCL



ES-41BKIO



ES-41BKSM



ES-51FTCL



ES-51CLIO



ES-51BKSM



7340



7322



7320



7321



7334B



8001CC



8010



# HEARING PROTECTION



The Safety Zone offers a variety of hearing protection. Ear plugs come in both corded and non-corded styles.

Item	Description	Quantity
7310	Pro-Guard® uncorded ear plugs	200 pr/box 10 bx/cs
7311C	Pro-Guard® corded ear plugs	100 pr/box 10 bx/cs
RH-QB3HYG	Howard Leight Banded Ear Plug, 23 NRR	1/bg 10bg/cs
RH-LL-1	Howard Leight Laser Lite Uncorded Ear Plug, 32 NRR	200/bx 10bx/cs
RH-LL-30	Howard Leight Laser Lite Corded Ear Plug, 32 NRR	100/bx 10bx/cs
RH-MAX-1	Howard Leight Max Uncorded Ear Plug, 33 NRR	200/bx 10bx/cs
RH-MAX-30	Howard Leight Max Corded Ear Plug, 33 NRR	100/bx 10bx/cs
RH-LPF-30	Howard Leight Max Lite Corded Ear Plug, 30 NRR	100/bx 10bx/cs
RH-LT-30	Howard Leight Lazer Trak Metal Detectable Corded Ear Plug, 32 NRR	100/bx 10bx/cs
RH-SDT-30	Howard Leight SmartFit Reusable Metal Detectable 25 NRR	100/bx 5bx/cs



# RESPIRATORS & MASKS



Item	Description	Quantity
MFB-3-EL-2K	3 ply ear loop procedural/face mask	50/box, 40 boxes/cs
7300B	Cone Mask w/elastic, non-rated, White	50/bx, 20 bx/cs (priced per box of 50)
7312B	N95 NIOSH Mask	20/bx, 12 bx/cs (priced per box of 20)
7314B	N95 NIOSH Mask with exhalation valve	10/bx, 12 bx/cs (priced per box of 10)

MFB-3-EL-2K



7300B



7312B



7314B



## Gilbert Says, Fit to Wear

Poorly fitting items can provide little defense against hazards. Even though PPE can be cumbersome or uncomfortable. **DO NOT** disregard. Don't put yourself at risk and make sure your PPE is fits properly.





# SHARP CONTAINERS & EYEWASH STATIONS



## Sharps Containers & Accessories

Item	Description	Quantity
7350	Sharps Container - 1 Quart	100/cs
7365	Sharps Container - 5 Quart	32/cs
7352	Sharps Container - 2 Gallon	30/cs
7352B	Wall Bracket - Fits 5 qt. #7365 & 2 Gallon #7352	10/cs
7352K	Key for Bracket Mounting	10/cs

7350



7365



7352



7352B

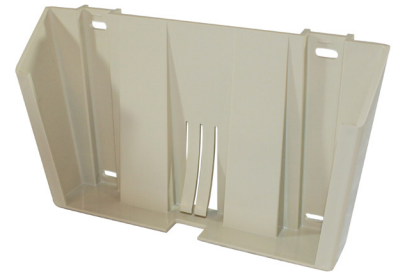

7352K



## Sharps Containers & Accessories

Item	Description	Quantity
K-FAK-24-102SZ	Double Eye Wash Station with two 16 Once Bottles	100/cs
K-FAK-24-101	Single Eye Wash Solution 16 Once Bottle Only	32/cs

K-FAK-24-102SZ



K-FAK-24-000SZ



# FIRST AID KITS



Item	Description	Quantity
K-FAK-10	First Aid Kit, 10 Person, Plastic	12/cs
K-FAK-25	First Aid Kit 25 Person Metal	12/cs
K-FAK-25-P	First Aid Kit, 25 Person, Plastic, w/Eyewash	12/cs
K-FAK-50-P	First Aid Kit, 50 Person, Plastic	6/cs
K-FAK-100	First Aid Kit, 100 Person, Metal	1/cs
21-004-084	First Aid Instant Cold Pack 4" x 5"	1/bx

K-FAK-10



K-FAK-25-P



K-FAK-50-P



K-FAK-100



K-FAK-10

- (2X) Fabric Fingertip Bandages
- (2X) Fabric Knuckle Bandages
- (4X) 3" X 3" Gauze Pads
- (1X) 1/2" Adhesive Tape
- (4X) Nitrile Exam Gloves
- (1X) Large Wound Pad
- (1X) First Aid Guide
- (1X) Plastic Case W/ O-Ring
- (1X) Triangular Bandage
- (1X) Bandage Scissors
- (1X) Forceps
- (10X) Antiseptic Towelettes
- (6X) Burn Cream Packets
- (6X) Triple Antibiotic Packets
- (1X) 2" Gauze Bandage
- (16X) Plastic Adhesive Strips

K-FAK-25-P

- (2X) Fabric Fingertip Bandages
- (2X) Fabric Knuckle Bandages
- (4X) 3" X 3" Gauze Pads
- (1X) 4" Gauze Pad
- (1X) Large Wound Pad
- (1X) 1/2" Adhesive Tape
- (4X) Latex Exam Gloves
- (1X) 1 Fl Oz Eye Wash Solution
- (1X) First Aid Guide
- (1X) Plastic Case W/ O-Ring
- (20X) Alcohol Antiseptic Wipes
- (6X) Antiseptic Towelettes
- (3X) Sting Relief Wipes
- (1X) Bandage Scissors
- (1X) Forceps
- (6X) Burn Cream Packets
- (6X) Triple Antibiotic Packets
- (1X) Instant Cold Pack
- (1X) Triangular Bandage
- (32X) Plastic Adhesive Strips

K-FAK-50-P

- (20X) Alcohol Antiseptic Wipes
- (15X) Antiseptic Towelettes
- (3X) Sting Relief Wipes
- (4X) PVP Iodine Wipes
- (1X) Bandage Scissors
- (1X) Forceps
- (12X) Burn Cream Packets
- (12X) Triple Antibiotic Packets
- (1X) 2" Elastic Bandage
- (1X) 2" Gauze Bandage
- (1X) 4" Gauze Bandage
- (1X) 1/2" Adhesive Tape
- (10X) Fabric Fingertip Bandages
- (10X) Fabric Knuckle Bandages
- (60X) Plastic Adhesive Strips
- (1X) Instant Cold Pack
- (1X) Triangular Bandages
- (5X) 3" X 3" Gauze Pads
- (4X) Latex Exam Gloves
- (1X) Large Wound Pad
- (1X) First Aid Guide
- (1X) Plastic Case W/ O-Ring

K-FAK-100

- (100X) Alcohol Antiseptic Wipes
- (2X) 5" X 9" Abdominal Pad
- (10X) 4" X 4" Gauze Pads
- (2X) Gauze Bandage
- (2X) 1/2" Adhesive Tape
- (4X) Sterile Eye Pads with Tape Strips
- (4X) Nitrile Exam Gloves
- (10X) Latex Exam Gloves
- (2X) Instant Cold Packs
- (50X) Extra Strength Non-Aspirin Tylenol
- (1X) Bandage Scissors
- (1X) Forceps
- (2X) Triangular Bandages
- (200X) 1" X 3" Plastic Adhesive Strips
- (15X) 2" X 3" Extra Large Bandages
- (15X) Knuckle Bandages
- (15X) Fingertip Bandages
- (10X) Sting Relief Wipes
- (25X) Burn Cream Packets
- (1X) 4 Fl Oz Eye Wash Solution
- (1X) 4 Fl Oz Burn Spray
- (1X) 2" Elastic Bandage
- (1X) 4" Elastic Bandage
- (1X) First Aid Guide
- (1X) Metal Cabinet

# BLOODBORNE PATHOGEN KITS

SAFETY ZONE™



Item	Description	Quantity
K-FAK-3060SZ	Bloodborne Pathogen Clean Up Kit with Wall Mountable Handle, Plastic	12/cs
7351	Bloodborne Pathogen Clean Up Kit	6/cs
7353	Bodily Fluid Cleanup Kit Co-Packaged W/Germicidal Wipes	6/cs
7354	Bodily Fluid Cleanup Kit W/O Disinfectant Wipes	6/cs

K-FAK-3060SZ



7351



7353



7354



## K-FAK-3060SZ

- (1X) Absorbant Spill Powder
- (1X) Red Biohazard Bag
- (1X) Clear Poly Bag
- (2X) Bag Ties
- (1X) Pair of Nitrile Gloves
- (10X) Paper Towels
- (1X) Co-Packaged with Germicidal Wipes
- (2X) Anti-Septic Towelettes
- (1X) Spatula and Scoop
- (1X) Plastic Case W/ O-Ring

## 7351

- (4X) Medical Examination Gloves
- (1X) BioScoop & Scraper
- (2X) Red BioHazard Waste Bags
- (8X) Absorbent Towels
- (2X) Antiseptic Towelettes XL
- (1X) Exposure Control Report Form
- (1X) Ear Loop Mask
- (1X) Apron
- (2X) Non-Slip Shoe Covers
- (1X) Blood Spill Clean Up Procedures English/Spanish
- (2X) Co-Packaged with Germicidal Wipes

## 7353

- (2X) Disposable Gloves
- (1X) Disposable Face Shield
- (1X) Disposable Face Mask
- (2X) Disposable Shoe Covers
- (1X) Disposable Apron
- (1X) Absorbent Pack,
- (2X) Disposable Towelettes
- (2X) Scoops/scrapers
- (2X) Red Biohazard Bags w/ Ties
- (1X) Disposable Towel
- (1X) Instruction Sheet
- (1X) HIV tuberculosis claim
- (2X) Co-Packaged with Germicidal Wipes

## 7354

- (2X) Disposable Gloves
- (1X) Disposable Face Shield
- (1X) Disposable Face Mask
- (2X) Disposable Shoe Covers
- (1X) Disposable Apron
- (1X) Absorbent Pack,
- (2X) Disposable Towelettes
- (2X) Scoops/scrapers
- (2X) Red Biohazard Bags w/ Ties
- (1X) Disposable Towel
- (1X) Instruction Sheet
- (1X) HIV tuberculosis claim

# BACK SUPPORTS, KNEE PADS & DISPENSER RACKS

## Back Supports & Knee Pads

Item	Description	Quantity
Z-BACKSUP-XS	Back Support with Elastic Back - XS	50/cs
Z-BACKSUP-SM	Back Support with Elastic Back - SM	50/cs
Z-BACKSUP-MD	Back Support with Elastic Back - MD	50/cs
Z-BACKSUP-LG	Back Support with Elastic Back - LG	50/cs
Z-BACKSUP-XL	Back Support with Elastic Back - XL	50/cs
Z-BACKSUP-2X	Back Support with Elastic Back - 2XL	50/cs
Z-BACKSUP-3X	Back Support with Elastic Back - 3XL	50/cs
Z-BACKSUP-4X	Back Support with Elastic Back - 4X	50/cs
7377	Pro-Guard® Soft Rubber Knee Pads, Sold by the Pair	40/cs

## Wall or Surface Mount Dispenser Racks

Item	Description	Quantity
D-100	Wall Mount Wire Rack for 50 & 100 Pack Disposable Gloves, Sold by the Each	48/cs
D-200	Wall Mount Wire Rack for GDSH & GDCP Pack Disposable Gloves, Sold by the Each	12/cs
D-200V	Wall Mount Wire Rack for 2 boxes, 50 & 100 Pack Disposable Gloves, Sold by the Each	6/cs
D-400	Wall Mount Wire Rack for 4 boxes, 50 & 100 Pack Disposable Gloves, Sold by the Each	6/cs
D-400AC	Wall Mount Acrylic Dispenser Holds 4 boxes, Sold by the Each	8/cs
D-900AC	Wall Mount Acrylic Dispenser for 100 count Bouffant Box, Sold by the Each	8/cs
8615H3	Wall Mount Wire 3 box holder	8/cs
8615	Wall Mount Acrylic Dispenser Holds 1 box, Sold by the Each	12/cs





## Banana Wet Floor Cones

Item	Description	Quantity
81001	Wet Floor Cone, CAUTION WET FLOOR, Trilingual, English/Spanish/French 2 ft. Yellow	3/cs
81101	Wet Floor Cone, CAUTION WET FLOOR, Trilingual, English/Spanish/French 3 ft. Yellow	3/cs
BWR24	Weight Ring for 2 ft. Banana Cone® Wet Floor Cone 7 lb. Black	3/cs
BWR36	Weight Ring for 3 ft. Banana Cone® Wet Floor Cone 9 lb. Black	3/cs
BBRNSTM	Replacement Stem for 2 ft. and 3 ft. Banana Cone® Wet Floor Cones 24 in. Brown	3/cs

## Wet Floor Signs

Item	Description	Quantity
9152W	Wet Floor Sign, CAUTION, English/Spanish Yellow	6/cs
9152BH	Wet Floor Sign with Handles and Base Vents, CAUTION, English/Spanish Yellow/Black	6/cs
24106	2x4™ Wet Floor Sign, CAUTION, Spanish/English Yellow	6/cs
24109	2x4™ Wet Floor Sign, NO ENTRY RESTROOM CLOSED, English Yellow	6/cs



# SAFETY SIGNS & ACCESSORIES

## Pop Up Safety Cones

Item	Description	Quantity
9182	Pop Up Safety Cone, CAUTION WET FLOOR, English/Spanish 31 in. Yellow/Black	24/cs
9183	Pop Up Safety Cone, CAUTION WET FLOOR, English/Spanish 20 in. Yellow/Black	48/cs

## Safety Poles

Item	Description	Quantity
91751	Extendable Safety Pole, CLOSED FOR CLEANING 30-44 in. Fluorescent Green	6/cs
91771	Extendable Safety Pole, CLOSED FOR MAINTENANCE 30-44 in. Fluorescent Green	6/cs

9183



91751



91771



# FOUR-SIDED FLOOR SIGNS & WET FLOOR CONES



## Four-Sided Floor Cones

Item	Description	Quantity
23812	Four-Sided Wet Floor Sign, CAUTION, English 25 in. Yellow	5/cs
23816	Four-Sided Wet Floor Sign, CAUTION, English/Spanish 25 in. Yellow	5/cs
23870	Four-Sided Wet Floor Sign, CAUTION, English 36 in. Yellow	5/cs
23879	Four-Sided Wet Floor Sign, CAUTION, English/Spanish 36 in. Yellow	5/cs
23887	Four-Sided Wet Floor Sign, CAUTION, English 36 in. Yellow	5/cs
26414	Weight Ring for 36 in. Four Sided Cone 9 lb. Black	3/cs

## Wet Floor Cone

Item	Description	Quantity
9100	Wet Floor Cone, WET FLOOR Orange	6/cs

23812



23816



23870



23879



23887



26414



9100



# BARRIER TAPE, LOCK-IN SIGN, SAFETY CONES & FLOOR DAMS

## Barrier Tape

Item	Description	Quantity
7327	Barrier Tape, CAUTION DO NOT ENTER 1000 ft Length Black/Yellow	1/pk 8/cs
7328	Barrier Tape, CAUTION 1000 ft Length Black/Yellow	1/pk 8/cs

## Lock-In Sign

Item	Description	Quantity
26401	Lock-In Sign for Four-Sided Wet Floor Cones 8 in. x 8 in. Red	50/cs

## Safety Cones

Item	Description	Quantity
7308	Safety Cone, Wide Body Design 18 in. Orange	6/cs
7309	Safety Cone, Wide Body Design 28 in. Orange	6/cs

## Floor Dams

Item	Description	Quantity
7240	Extendable Floor Dam 22-40 in. Fluorescent Yellow	1/cs
7264	Extendable Floor Dam 36-64 in. Fluorescent Yellow	1/cs







## SDS Information Center

Item	Description	Quantity
799190	SDS Center, Red/White	1/cs
799171	SDS Replacement Binder 2.5 In Red on White for #799190	15/cs

## Hand Sanitizer & PPE Station

Item	Description	Quantity
9300	Metal Hand Sanitizer Dispenser Stand Black	1/cs
9302	Metal Disposable Glove Holder Black	15/cs



# GLOVE CHEMICAL RESISTANT CHART

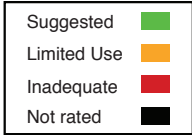

## Chemical Resistance Chart

This chemical chart is for reference use only. We recommend on-site testing of all gloves and provide free samples to determine safe usage.



	Latex	Nitrile	Vinyl		Latex	Nitrile	Vinyl
Acetaldehyde, 99.5%	Green	Yellow	Red	Hydrochloric Acid, 38%	Green	Green	Green
Acetic Acid	Green	Green	Green	Hydrofluoric Acid, 48%	Green	Green	Green
Acetone, 99.5%	Green	Red	Red	Hydrogen Peroxide, 30%	Green	Green	Green
Acetonitrile, 99%	Green	Green	Red	Hydroquinone	Green	Green	Green
Acrylic Acid, 99%	Green	Yellow	Black	Hypophosphorus Acid, 50%	Yellow	Red	Red
Acrylonitrile	Green	Green	Yellow	Iodine	Green	Green	Green
Ammonium Fluoride, 40%	Green	Green	Green	Isobutyl Alcohol, 99%	Green	Green	Green
Ammonium Hydroxide, 85%	Green	Red	Green	Iso-Octane, 99% <sup>4</sup>	Yellow	Green	Red
Amyl Acetate, 100%	Red	Green	Yellow	Isopropanol	Black	Green	Black
Amyl Alcohol, 99%	Green	Green	Yellow	Isopropyl Alcohol, 99%	Yellow	Green	Green
Aniline, 99%	Yellow	Red	Yellow	Isopropyl Benzene	Black	Green	Black
Animal Fats	Red	Green	Green	Kerosene, 100%	Green	Green	Red
Aqua Regia	Red	Green	Green	Lactic Acid, 85%	Green	Green	Green
Battery Acid	Green	Green	Green	Lauric Acid, 36%	Green	Green	Yellow
Benzaldehyde, 99.5%	Yellow	Red	Yellow	Linoleic Acid	Red	Green	Green
Benzene	Red	Green	Yellow	Linseed Oil	Red	Green	Green
Benzyl Chloride	Yellow	Green	Red	Maleic Acid, 100%	Green	Green	Green
Bromine	Green	Black	Green	Methanol	Black	Green	Black
Bromopropionic Acid, Sat	Green	Green	Black	Methyl Acetate	Red	Red	Black
Butane	Red	Green	Red	Methyl Alcohol, 99.9%	Green	Green	Green
2-Butoxyethanol	Black	Green	Green	Methylamine, 40%	Green	Green	Green
Butyl Acetate, 99%	Red	Yellow	Red	Methyl-Butyl Ether, 99.8%	Red	Green	Black
Butyl Alcohol, 99%	Green	Green	Green	Methyl Cellosolve, 99%	Yellow	Yellow	Red
Butyl Cellosolve, 99%	Green	Green	Red	Methylamine	Green	Green	Green
Butyrolactone, 99%	Green	Red	Black	Methyl Chloride	Red	Red	Red
Calcium Hypochlorite	Red	Green	Green	Methylene Chloride	Yellow	Green	Yellow
Carbolic Acid	Red	Red	Green	Methyl Ethyl Ketone, 99%	Yellow	Red	Red
Carbon Dichloride	Black	Green	Black	Methyl Isobutyl Ketone	Yellow	Red	Black
Carbon Disulfide, 99.9%	Red	Yellow	Red	Methyl Methacrylate	Red	Red	Black
Carbon Tetrachloride, 99%	Green	Green	Yellow	Methyl-T-Butyl Ether	Black	Green	Green
Castor Oil	Green	Green	Green	Mineral Oil	Red	Green	Yellow
Cellosolve Acetate, 99%	Green	Green	Red	Mineral Spirits, 100%	Red	Green	Red
Cellosolve Solvent	Green	Green	Black	Monoethanolamine, 99%	Yellow	Green	Green
Chlorine	Green	Green	Green	Morpholine, 99%	Yellow	Red	Yellow
Chloroacetone	Yellow	Black	Green	Muriatic Acid, 100%	Green	Green	Green
Chlorobenzene	Green	Green	Yellow	Naphtha VM&P, 100%	Red	Green	Red
Chloroform	Black	Green	Black	N-Methyl-2 Pyrrolidone, 99%	Yellow	Red	Black
Chloronaphthalenes	Black	Yellow	Black	Naphthalene	Green	Green	Green
Chlorothene YG	Black	Yellow	Red	Nitric Acid, 10%	Green	Green	Green
Chromic Acid, 50%	Red	Yellow	Green	Nitric Acid, 70%	Red	Red	Yellow
Citric Acid, 10%	Green	Green	Green	Nitrobenzene, 99%	Yellow	Red	Red
Cottonseed Oil	Red	Green	Green	Nitromethane, 95.5%	Green	Red	Green
Creosol	Red	Green	Yellow	Nitropropane, 95.5%	Green	Red	Black
Cumene	Black	Green	Black	Octyl Alcohol, 99%	Green	Green	Green
Cutting Oil	Yellow	Green	Red	Oleic Acid, 99%	Green	Green	Green
Cyclohexane	Red	Green	Red	Oxalic Acid, 12.5%	Green	Green	Green
Cyclohexanol, 98%	Green	Green	Green	Paint Remover	Yellow	Green	Green
Diacetone Alcohol, 99%	Yellow	Green	Yellow	Palmitic Acid, Sat.	Green	Green	Green
Dibutyl Phthalate, 99%	Yellow	Green	Red	Pentachlorophenol, 35%	Red	Green	Black
Diamine	Black	Green	Black	Pentane, 98%	Red	Green	Green
Diethylamine, 99%	Red	Green	Red	Perchloric Acid, 60%	Yellow	Green	Green
Diethyl Ether	Yellow	Green	Red	Perchloromethylene	Black	Green	Black
Di-Isobutyl Ketone, 80%	Yellow	Green	Green	Perfluoreum Ether	Black	Green	Green
Dimethyl Acetamide, 99%	Yellow	Red	Green	Phenol, 90%	Green	Red	Green
N,N-Dimethyl Formamide, 99%	Green	Red	Green	Phosphoric Acid, 85%	Green	Green	Green
Dimethyl Sulfoxide, 99%	Green	Green	Red	Picric Acid	Green	Green	Green
Diocetyl Phthalate, 99%	Yellow	Green	Black	Potassium Hydroxide, 50%	Green	Green	Green
1,4-Dioxane, 99.9%	Yellow	Red	Yellow	Printing Ink	Green	Green	Yellow
Epichlorohydrin, 99%	Black	Red	Black	Propyl Acetate, 99%	Red	Yellow	Yellow
Ethanol	Black	Green	Black	Propyl Alcohol, 96%	Green	Green	Yellow
2-Ethoxyethanol	Black	Green	Black	Propylene Oxide	Red	Black	Green
Ethyl Acetate, 99%	Yellow	Red	Red	Pyridine, 99%	Yellow	Red	Black
Ethyl Alcohol, 90%	Green	Green	Yellow	Rubber Solvent, 100%	Red	Green	Red
Ethyl Ether, 99%	Yellow	Green	Green	Rule Solvent	Black	Green	Black
Ethylene Dichloride	Red	Green	Red	Sodium Hydroxide, 50%	Green	Green	Green
Ethylene Glycol, 99%	Green	Green	Black	Sodium Hypochlorite	Green	Yellow	Green
Ethyl Glycol Ether, 99%	Yellow	Yellow	Black	Stoddard Solvent, 99%	Red	Red	Green
Ethylene Trichloride	Red	Red	Black	Styrene	Green	Yellow	Green
Fluorine	Green	Black	Green	Sulfuric Acid, 95%	Green	Green	Green
Formaldehyde, 99%	Green	Green	Green	Tannic Acid, 37.5%	Green	Green	Green
Formalin Solution	Black	Green	Black	1,1,2,2-Tetrachloroethane, 99%	Red	Red	Black
Formic Acid, 95%	Green	Yellow	Green	Tetrachloroethylene, 100%	Red	Red	Green
Freon TE, 99%	Red	Yellow	Yellow	Toluene, 99%	Red	Green	Yellow
Furfural, 99%	Green	Red	Red	Toluene Di-Isocyanate	Red	Black	Red
Gasoline, 100%	Red	Green	Yellow	1,1,1-Trichloroethane, 99%	Red	Red	Black
Glutaraldehyde, 25%	Red	Green	Yellow	Trichloroethylene	Red	Green	Yellow
Glycerine	Green	Green	Green	Tricresyl Phosphate, 90%	Red	Green	Yellow
Glycerol	Green	Green	Green	Triethanolamine, 85%	Yellow	Green	Green
Heptane	Black	Green	Black	Tung Oil	Black	Green	Yellow
Hexamethyldisilazine, 97%	Green	Green	Black	Turbine Oil	Red	Green	Yellow
Hexane, 99%	Red	Green	Red	Turpentine, 100%	Red	Green	Yellow
Hydraulic Fluid- Petrol Based	Red	Green	Green	Vegetable Oil	Red	Green	Yellow
Hydraulic Fluid- Ester Based	Red	Red	Red	Vinyl Acetate	Red	Yellow	Red
Hydrazine, 65%	Red	Green	Green	Xylene	Red	Yellow	Red

# GLOVE SIZING CHART



Align hand here

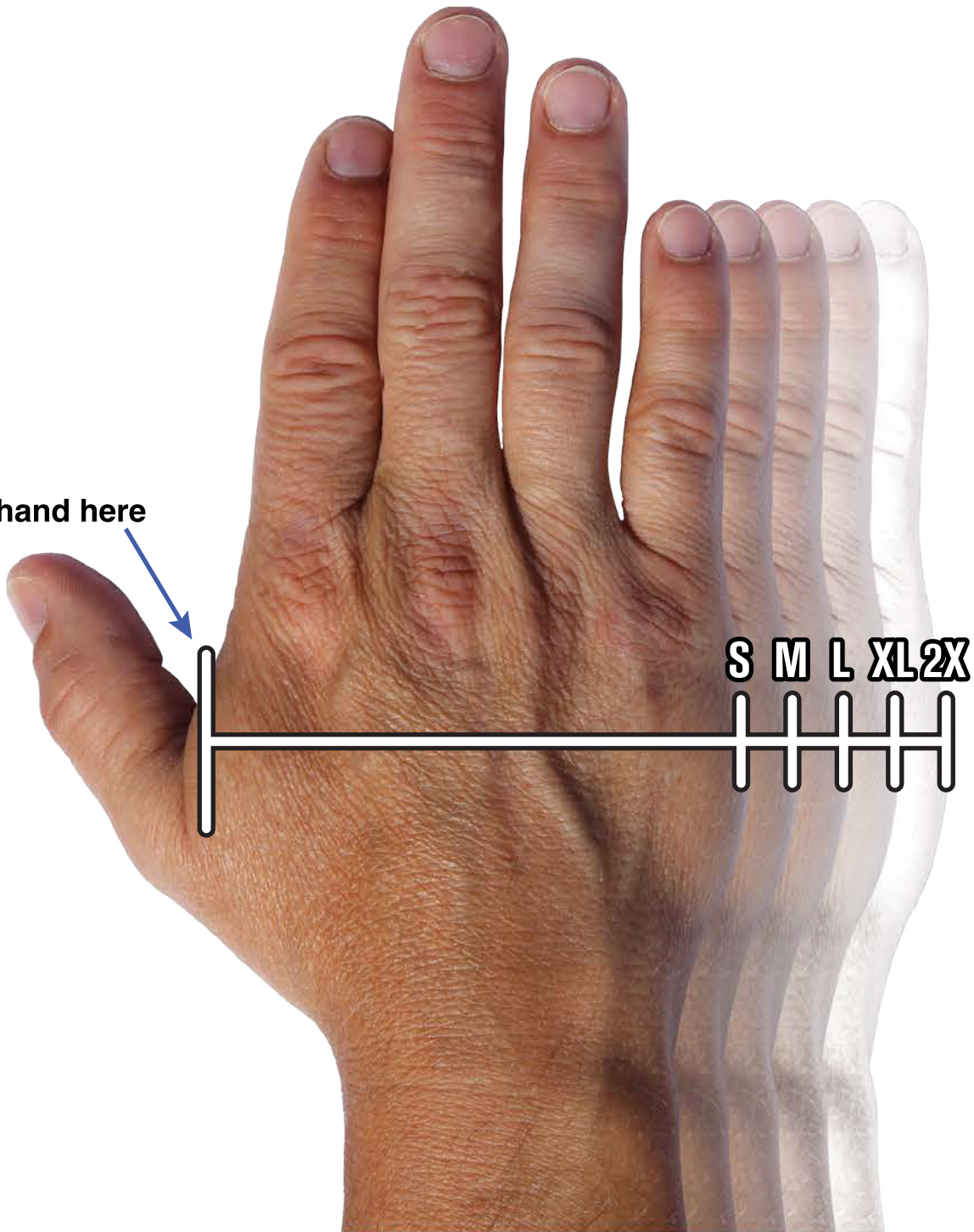



**ProGuard®**



**DiversaMed®**



**Gator®**



**Oxygen-Pro**



**True Count Cutlery**



**Naturelle®**

# Your Go-To for

 **Cleaning & Dusting**

 **Dispensing**

 **Floor Care**

 **Gloves**

 **Microfiber**

 **Personal Protective Equipment**

 **Receptacles & Material Handling**

 **Safety**

 **Washroom**

**impact**  
Products



 **Supply Source**

SupplySourceGlobal.com

1.800.333.1541